



# ABITAT 67 Moshe Safdie



HENAO MELENDEZ, BRANDON  
MARTÍNEZ DEL RIO, ALEX  
MARTÍNEZ MARHUENDA, MANUEL



# ABITAT 67

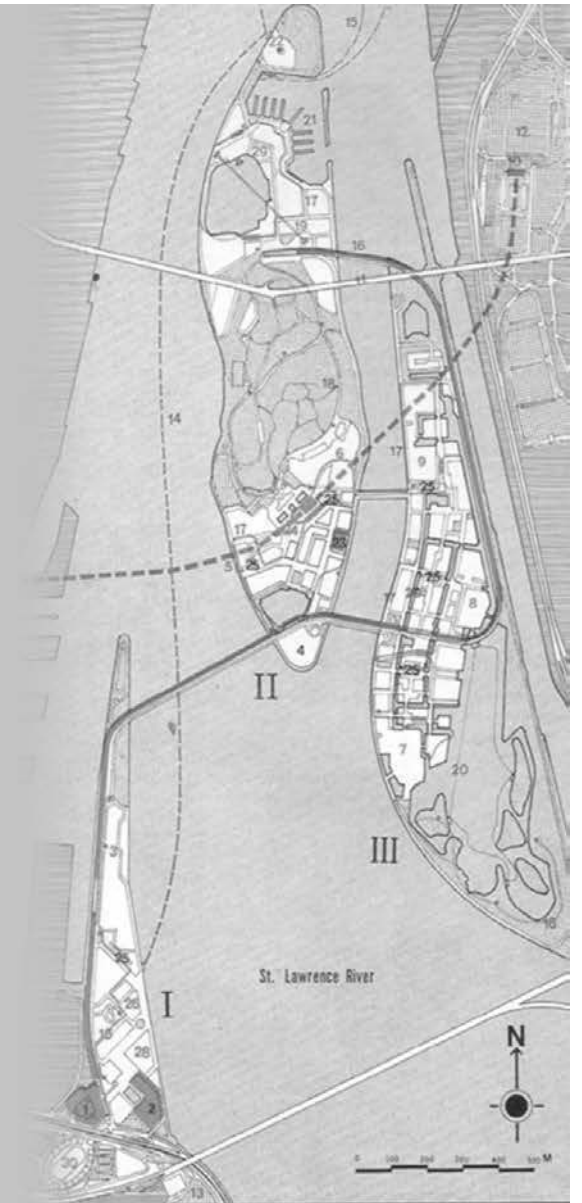

H

ABITAT 67

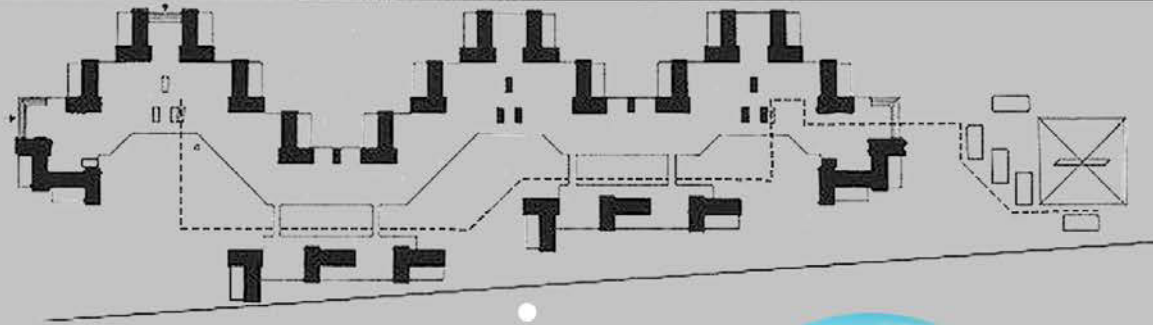



# ABITAT 67

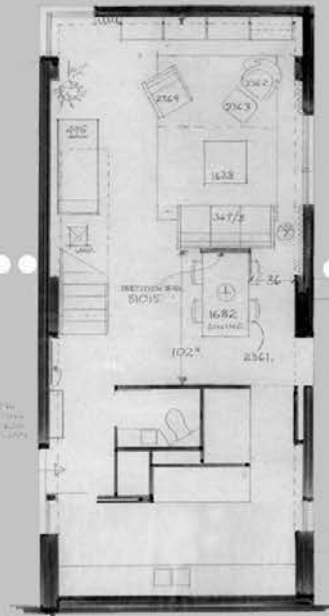
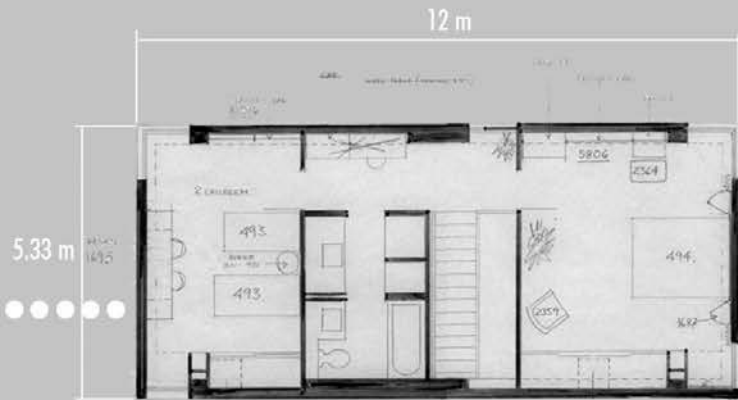



# ABITAT 67

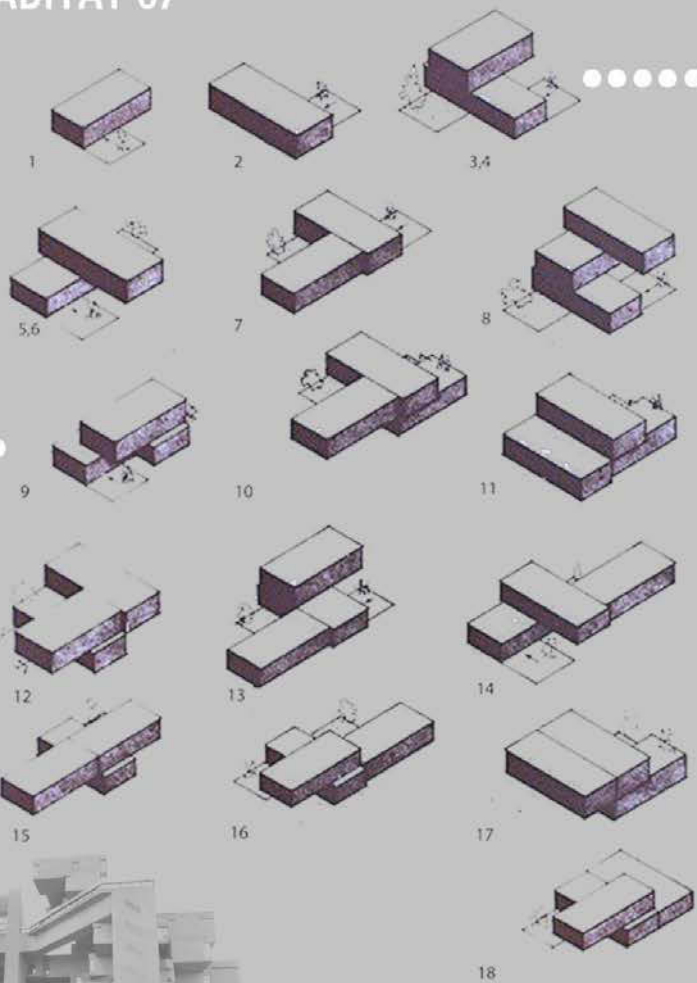

# H

## ABITAT 67



# H

## ABITAT 67



# C ONJUNTO





# 1 PLATAFORMA

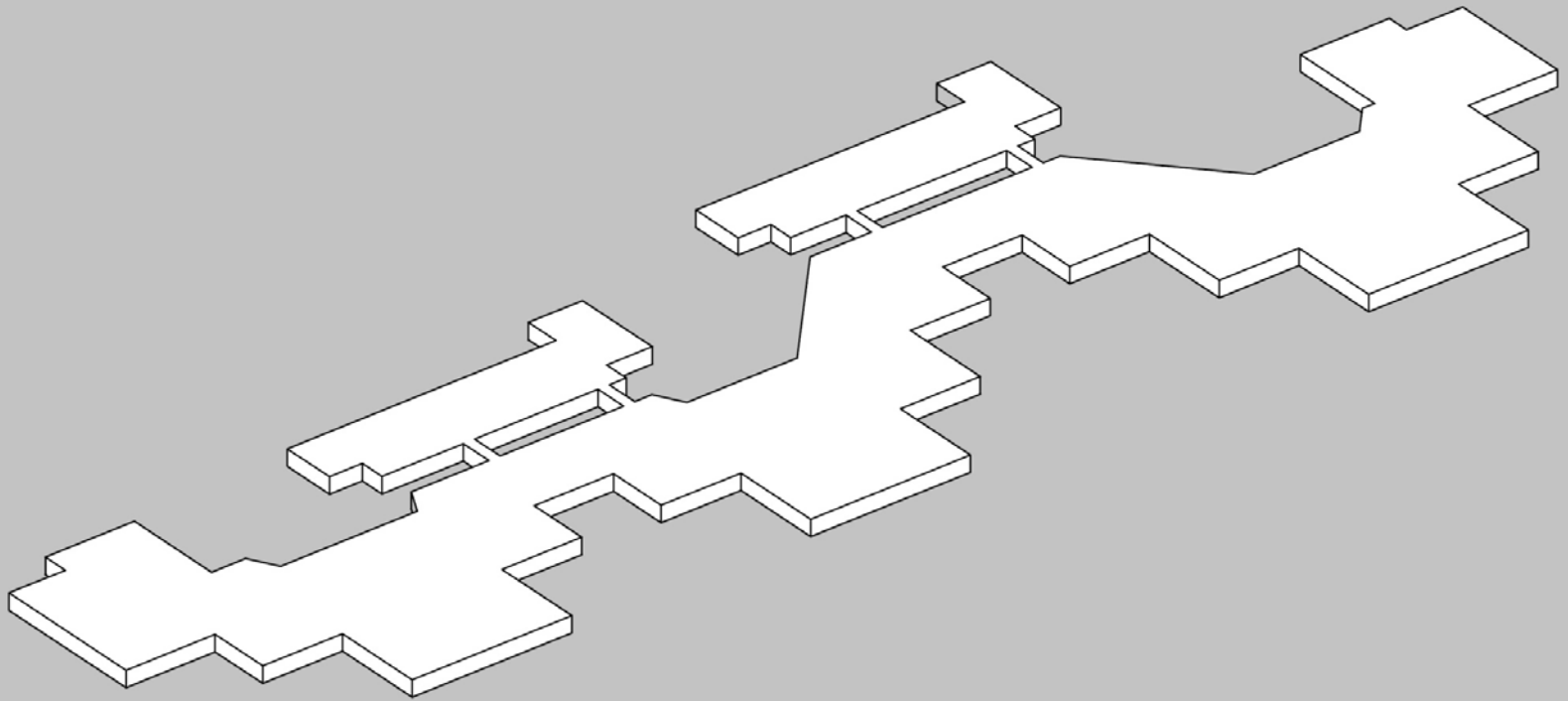

# 1 PLATAFORMA

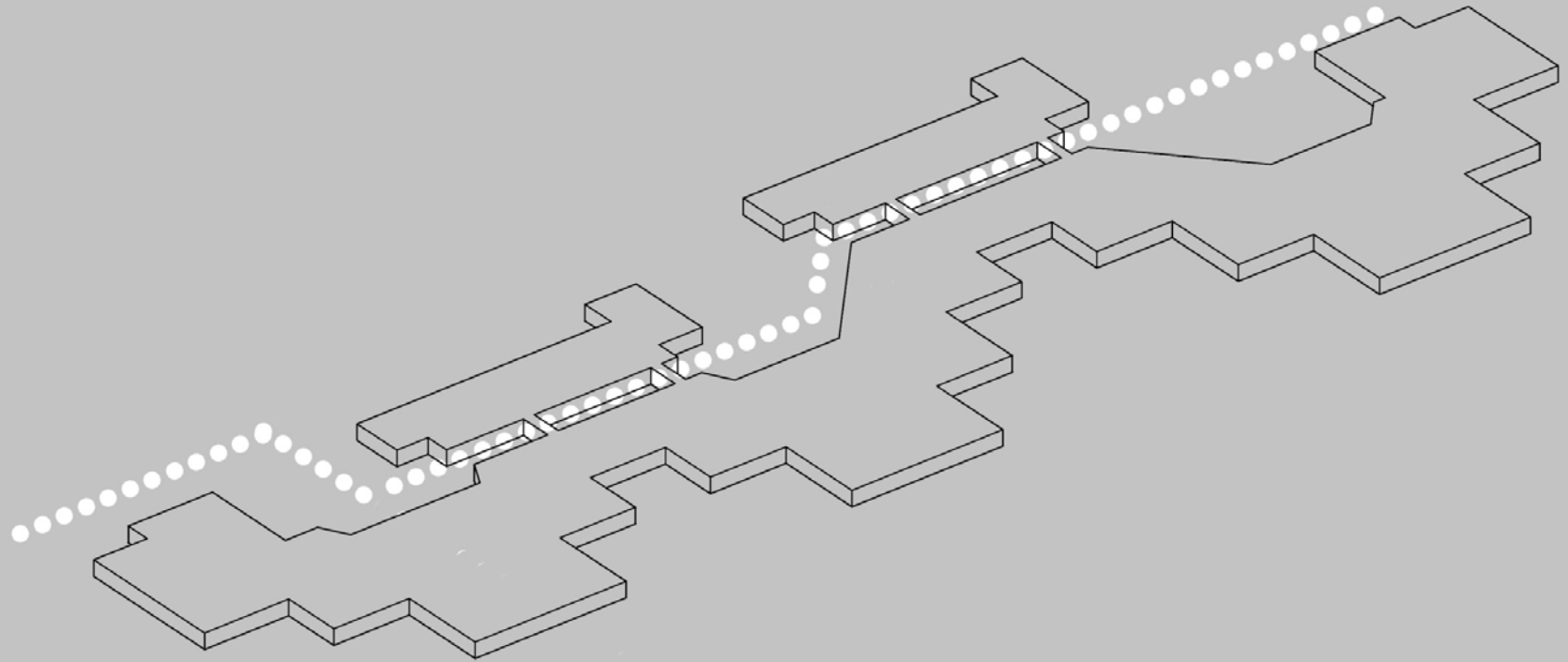

# 1 PLATAFORMA

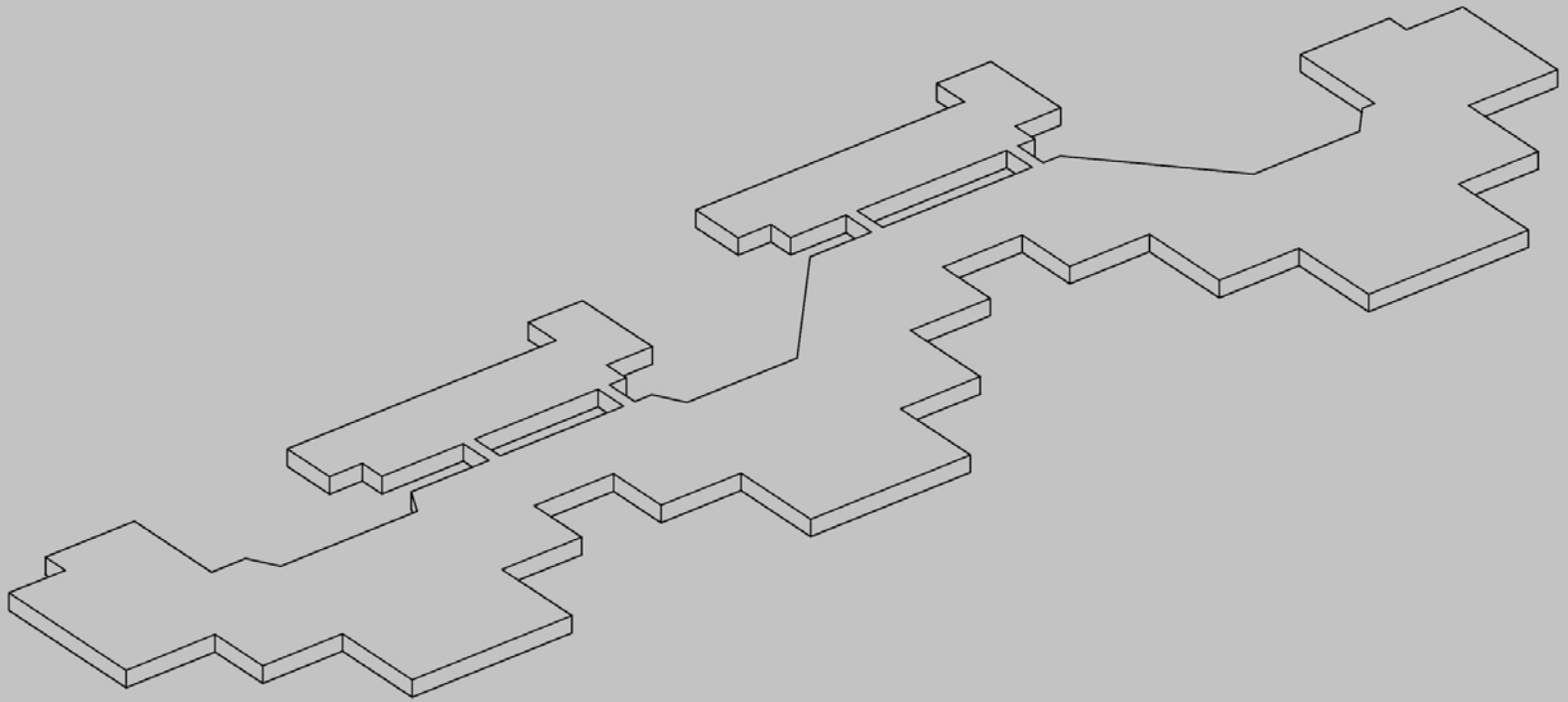

## 2 ESCALERAS

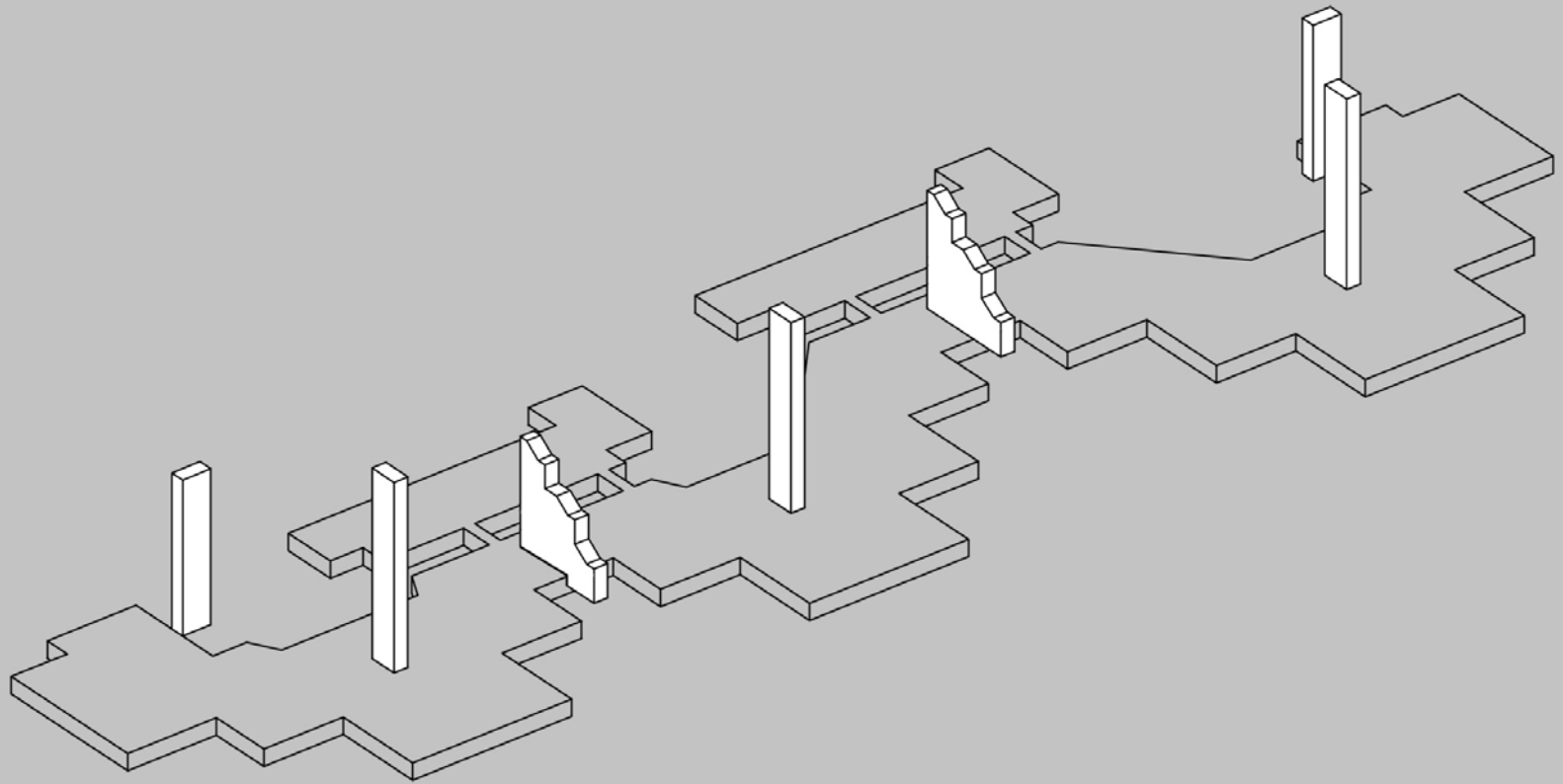

## 2 ESCALERAS

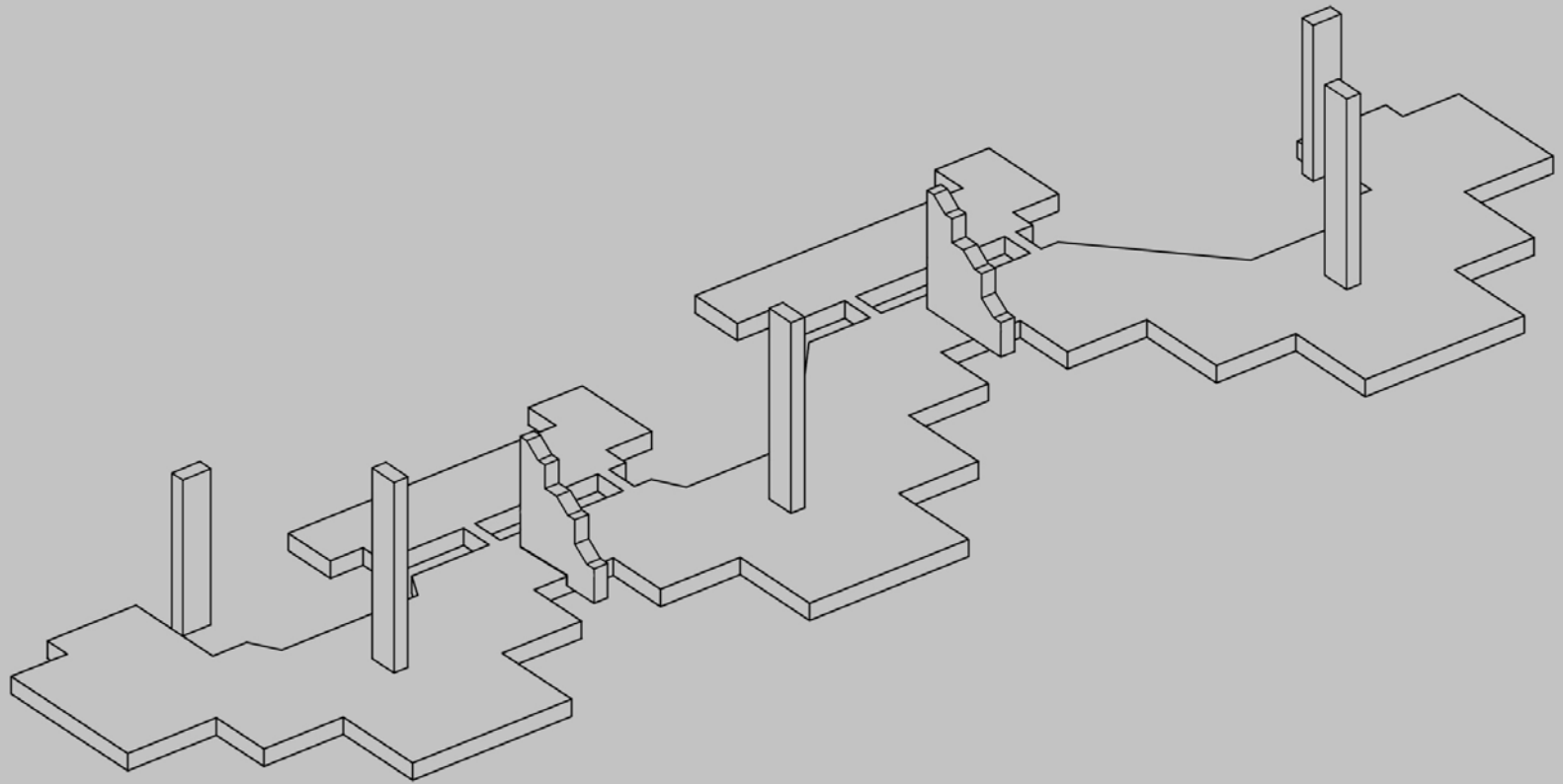

# 3 ASCENSORES

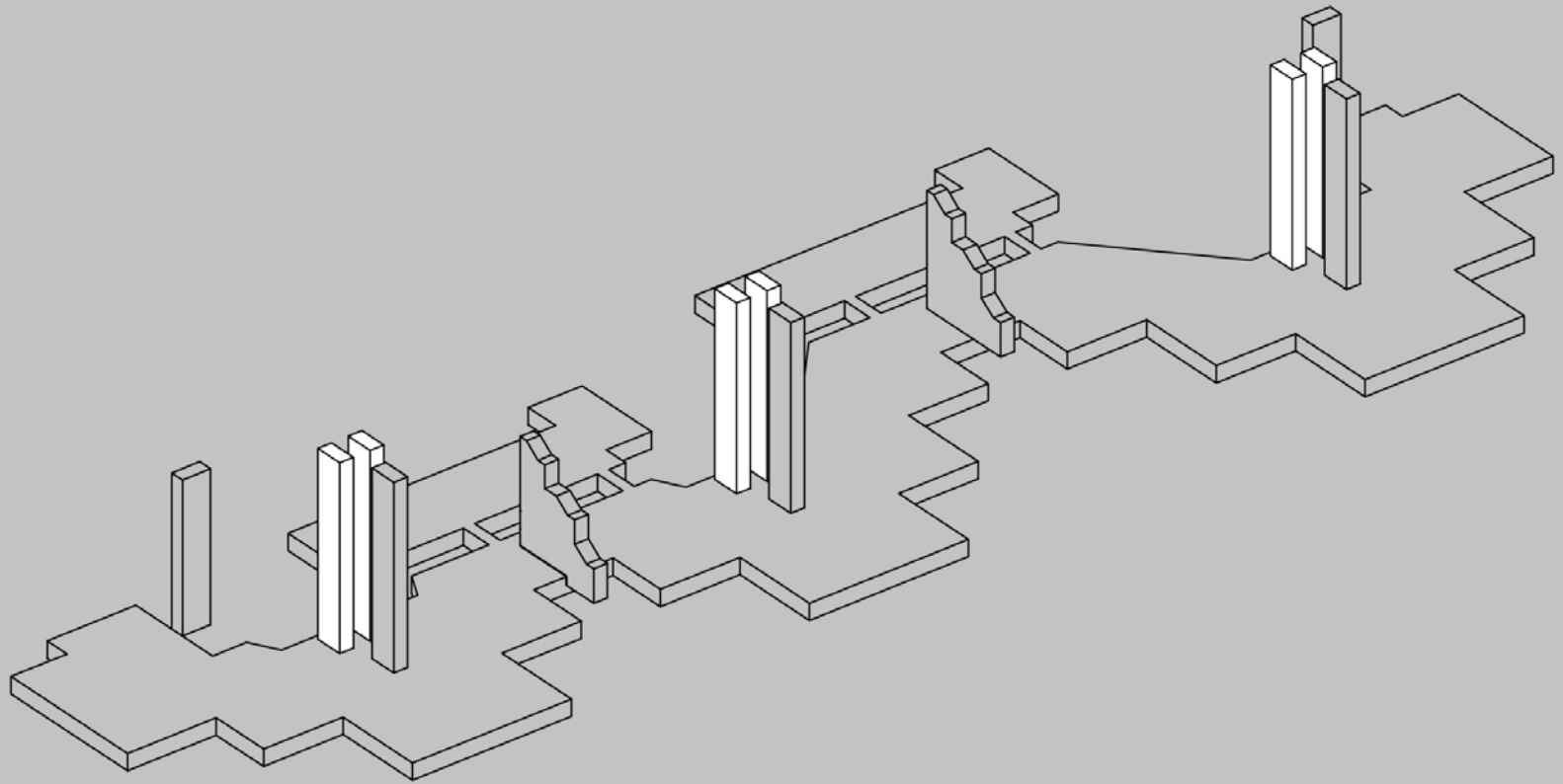

# 3 ASCENSORES

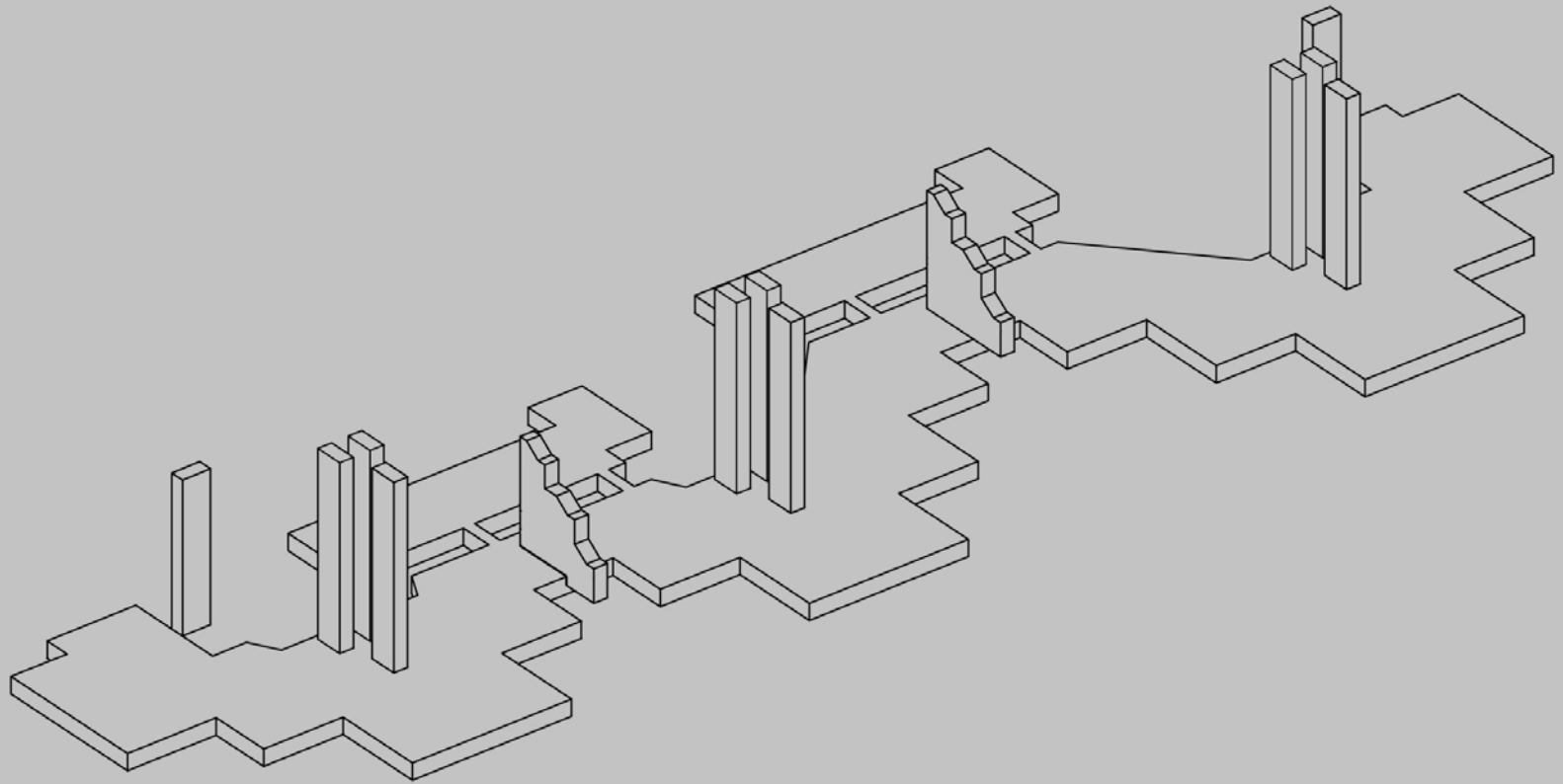

# 4 PRIMERA PLANTA

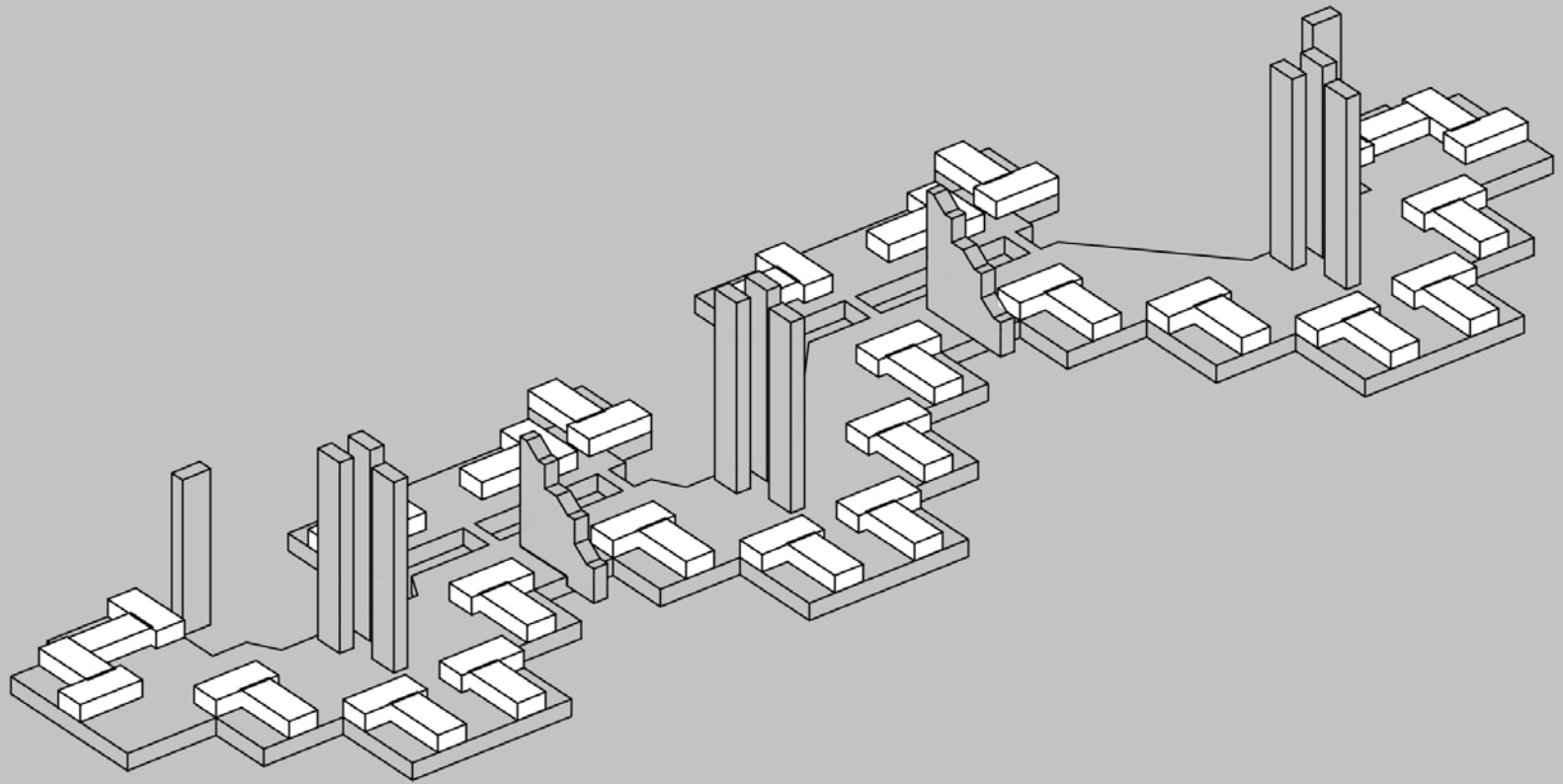



# 4 PRIMERA PLANTA

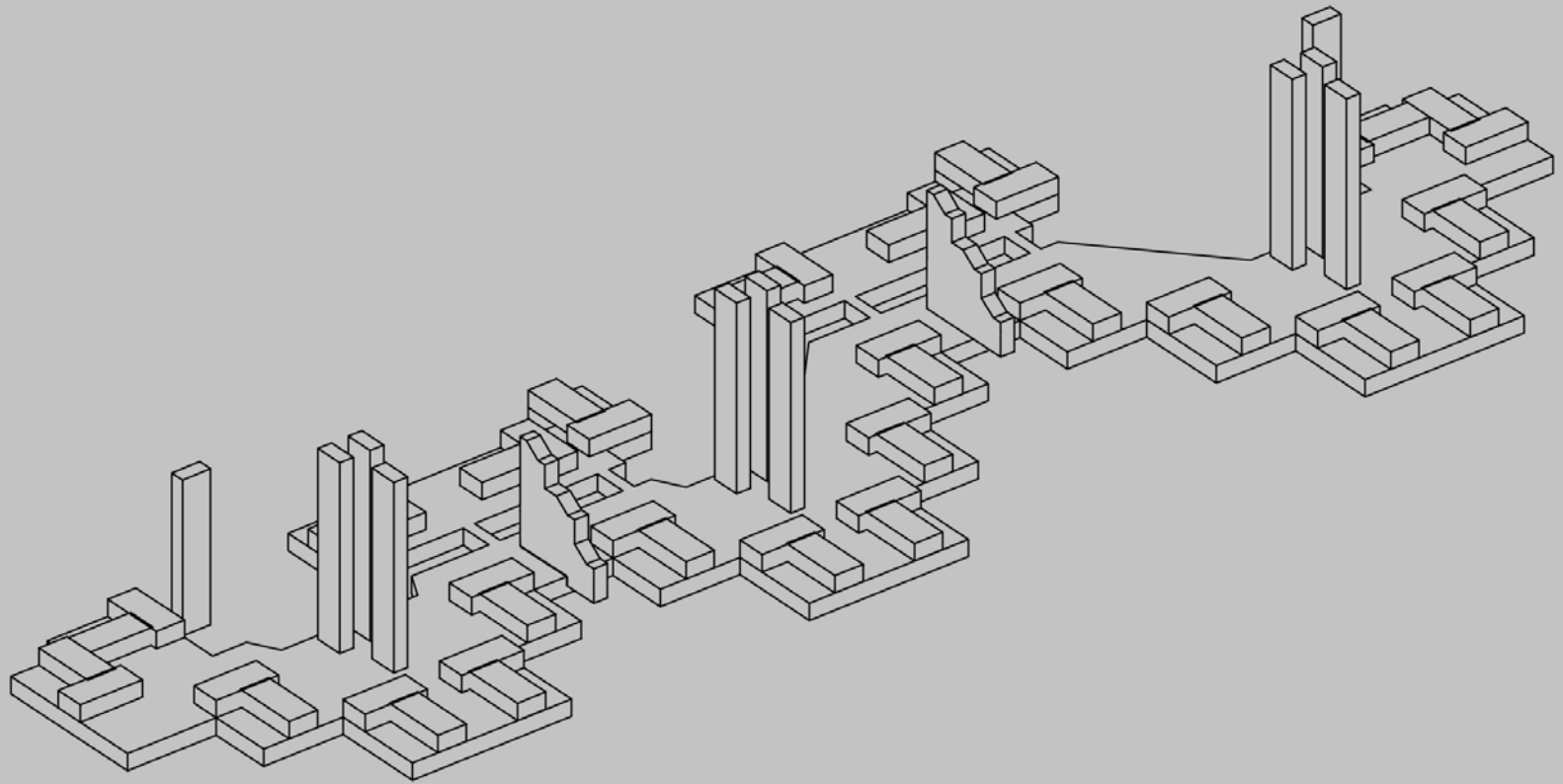

# 5 SEGUNDA PLANTA

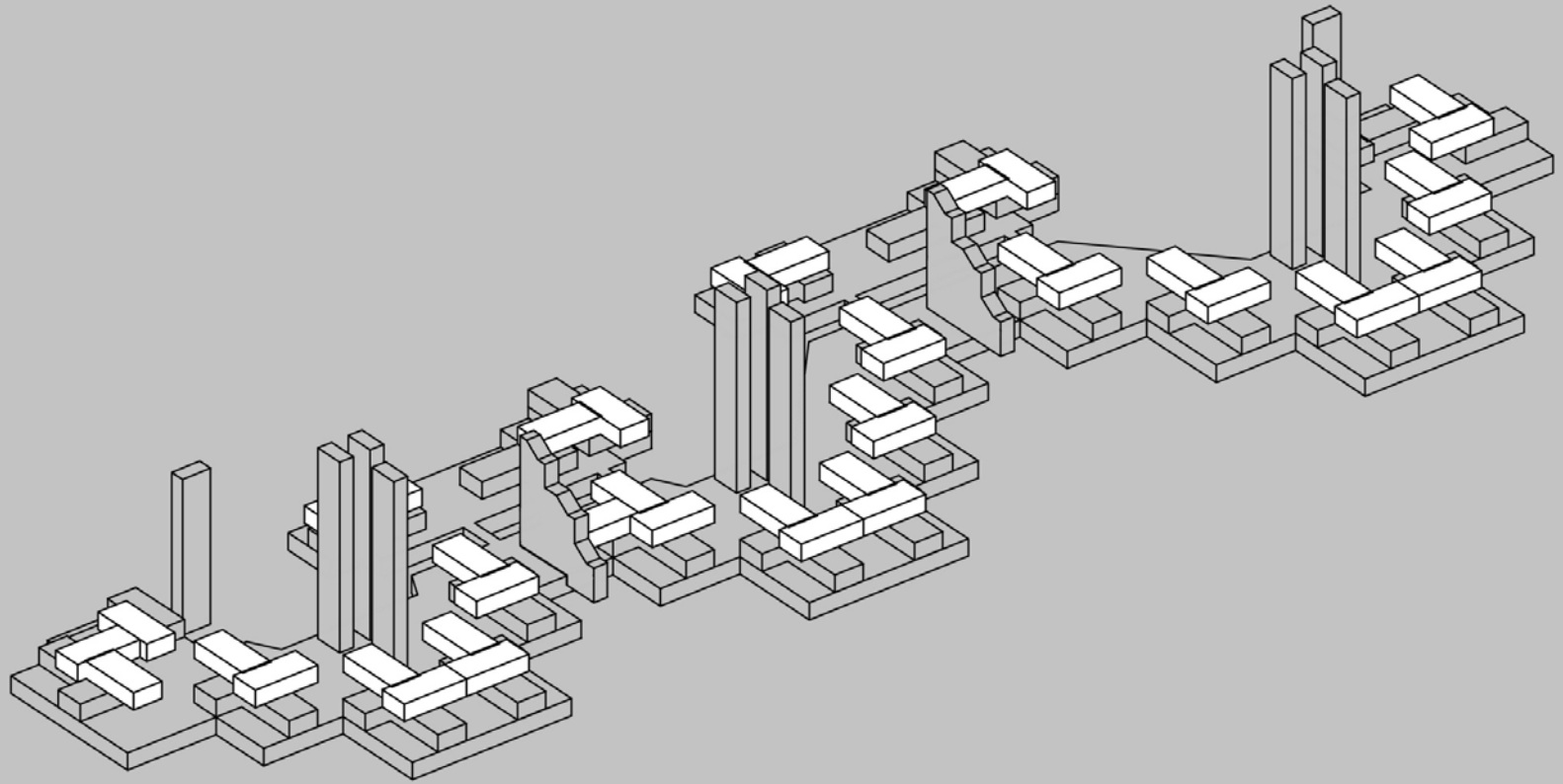

# 5 SEGUNDA PLANTA

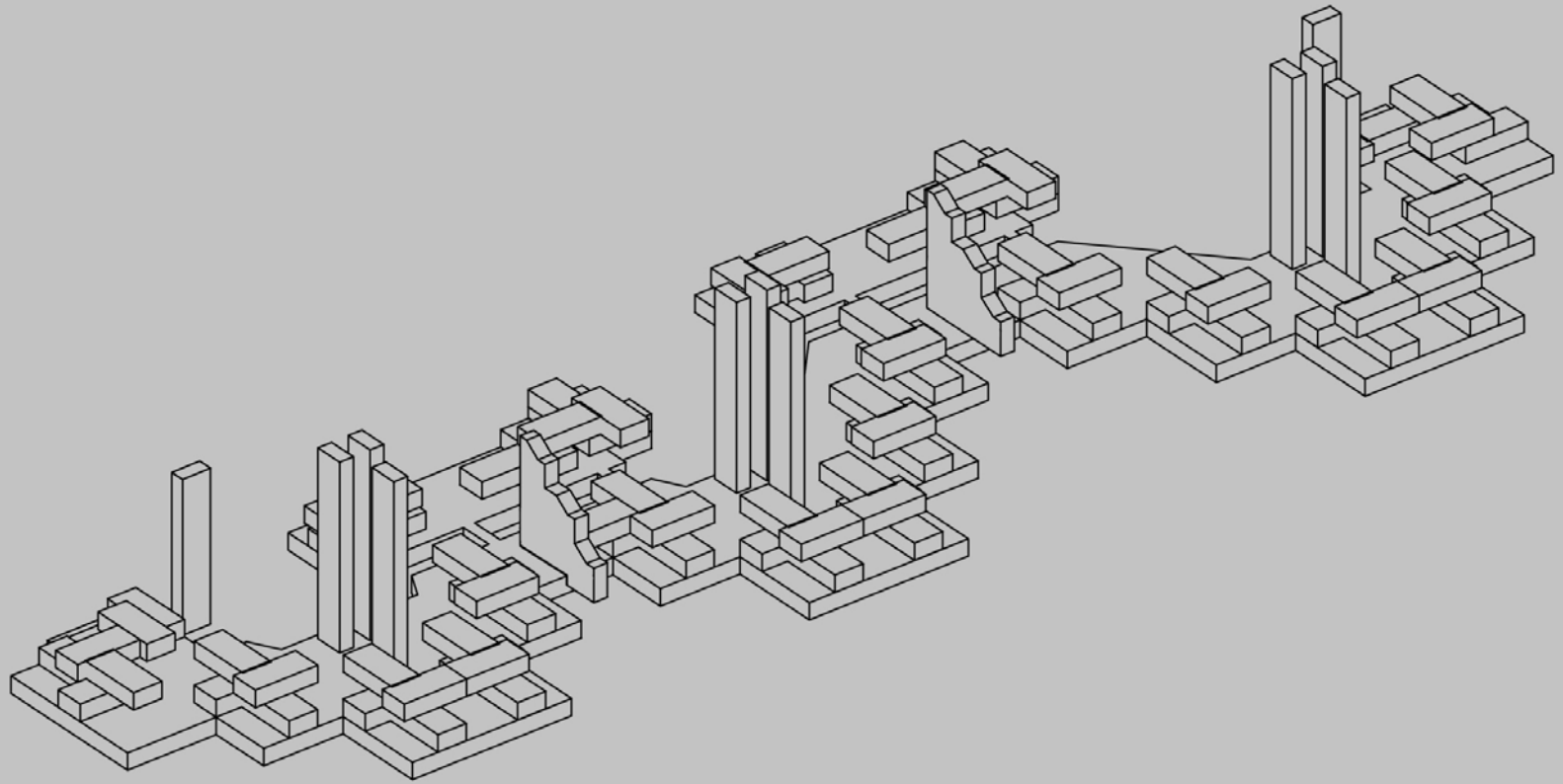

# 6 TERCERA PLANTA

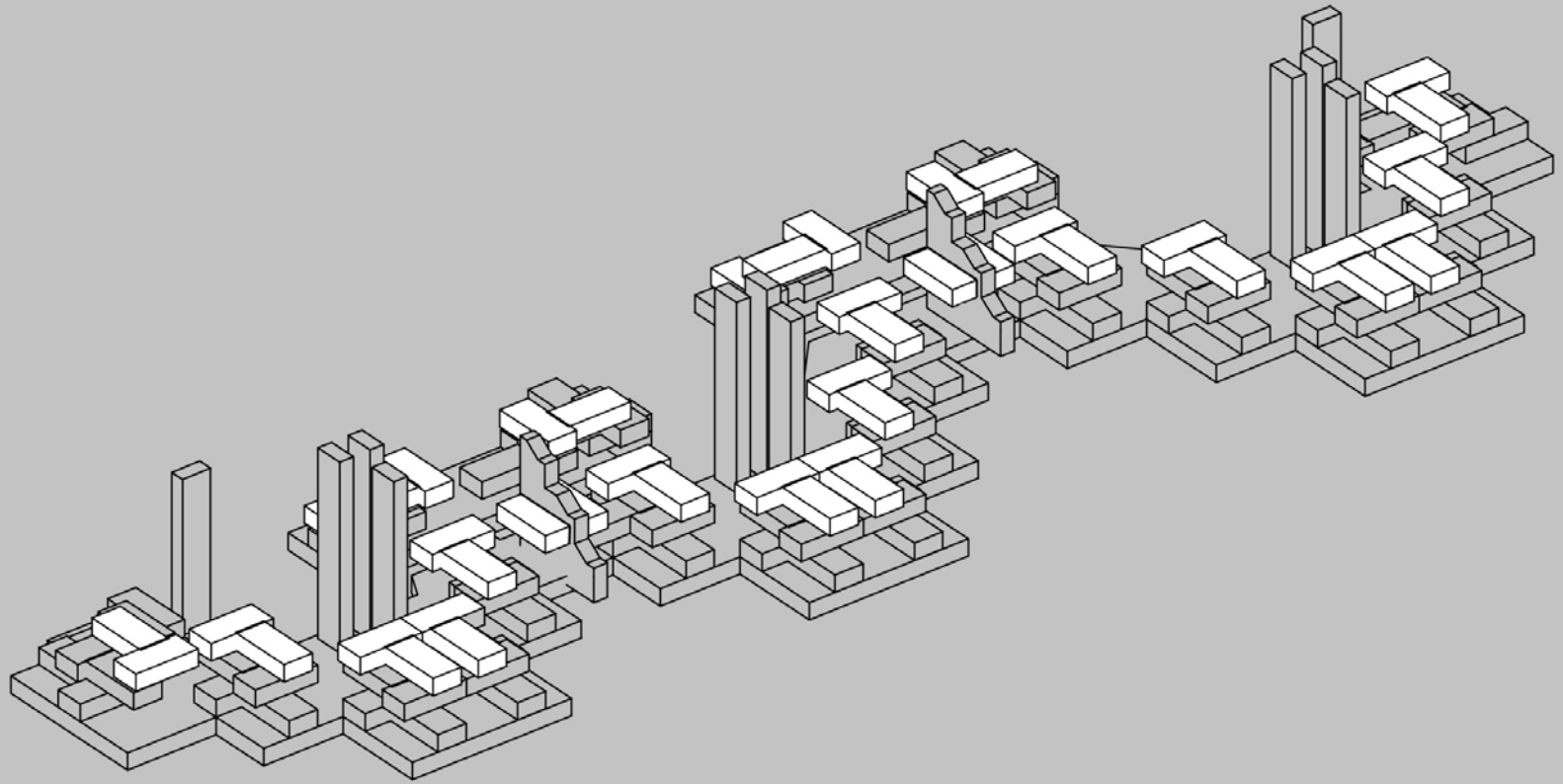

# 6 TERCERA PLANTA

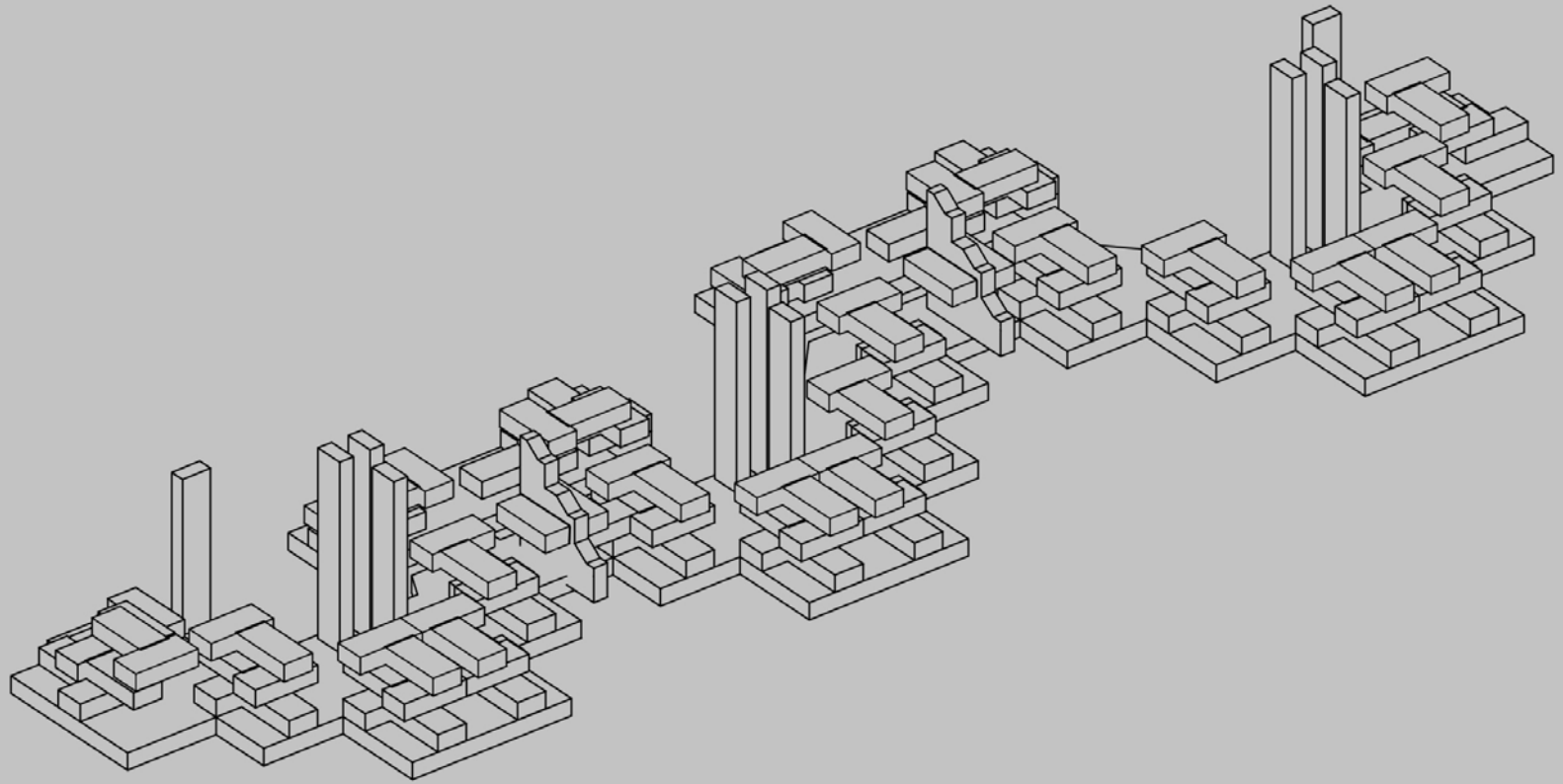

7

# CUARTA PLANTA

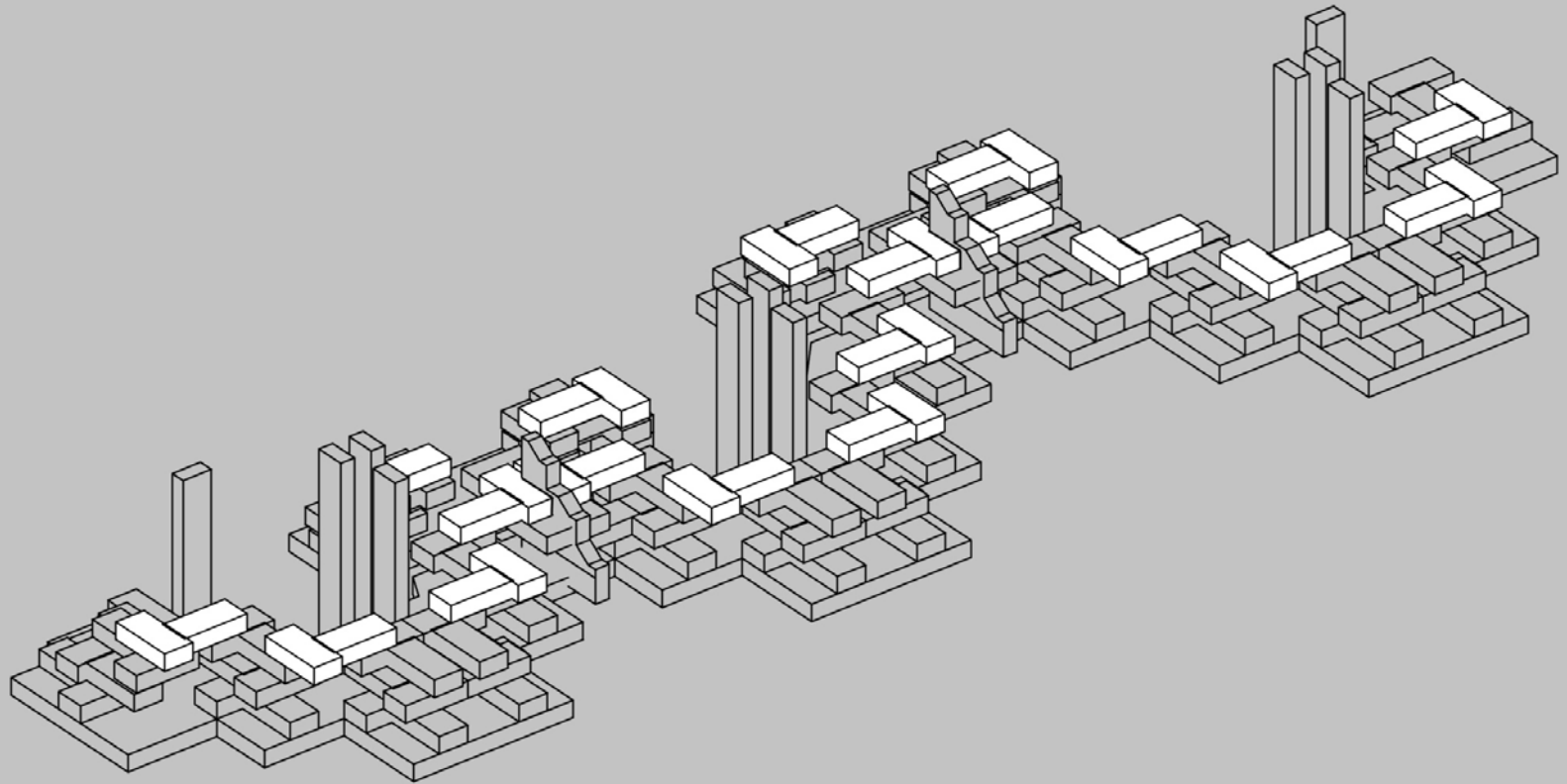

7

# CUARTA PLANTA

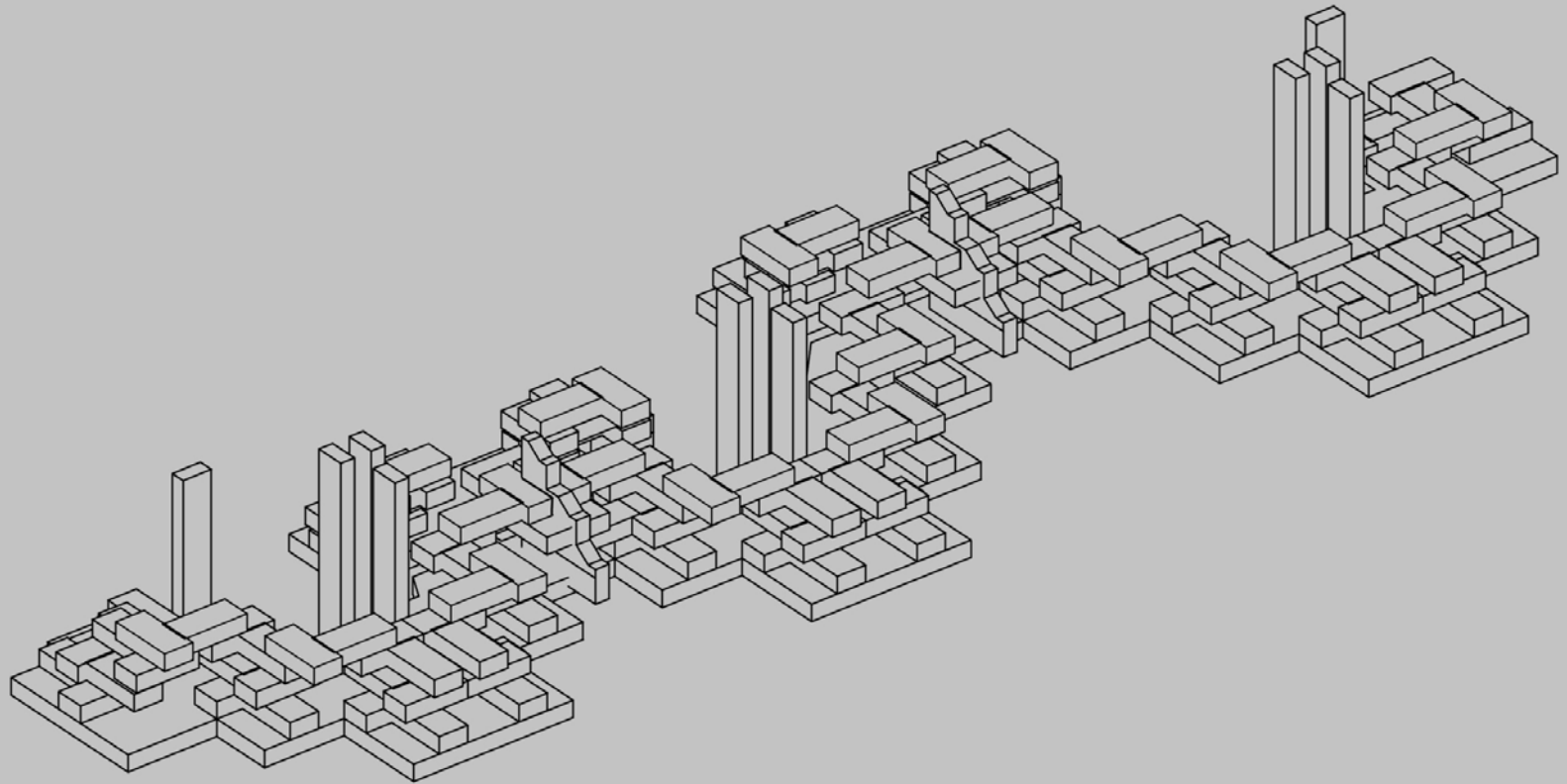

# 8 RECORRIDOS I

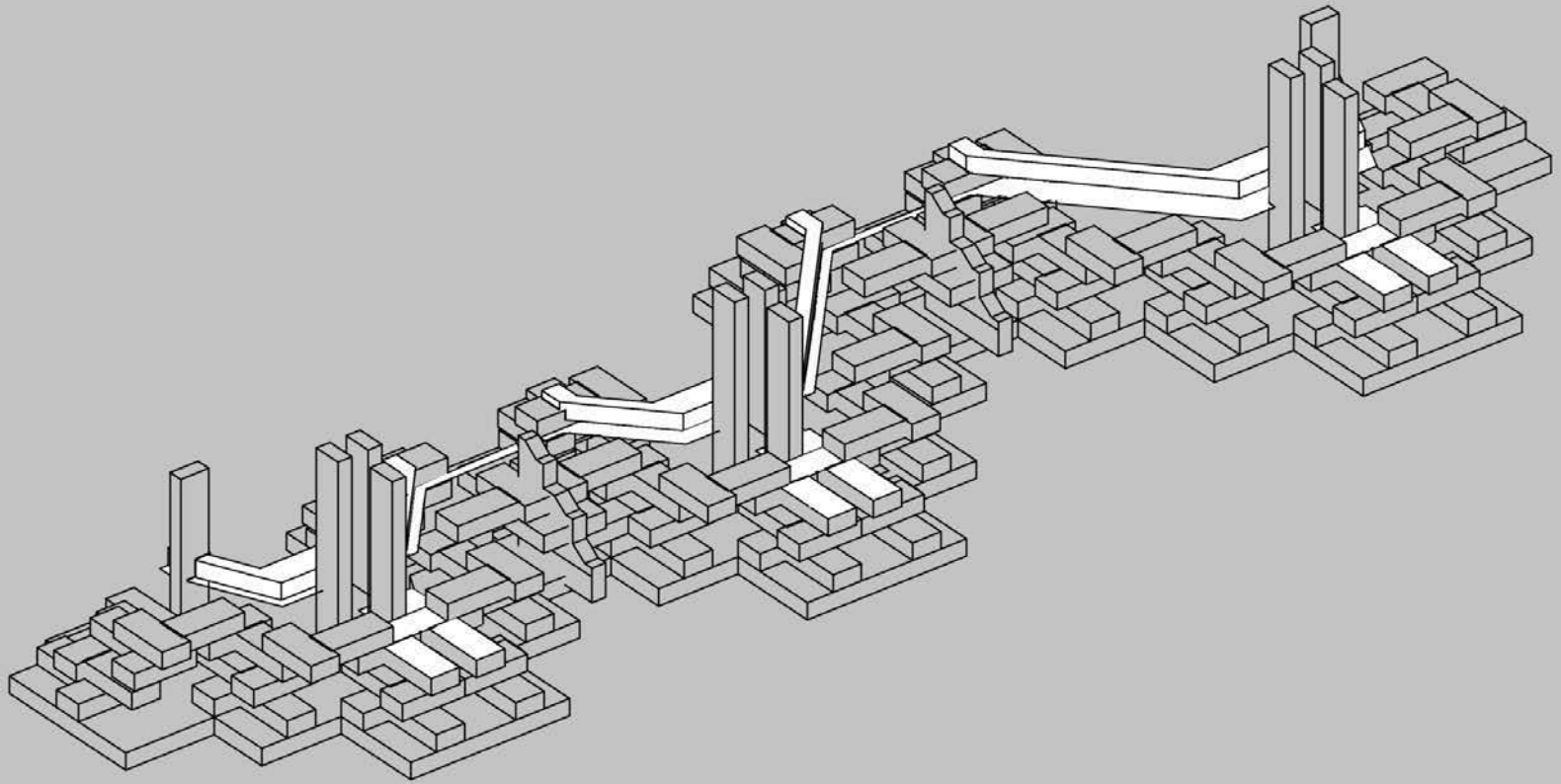



# 8 RECORRIDOS I

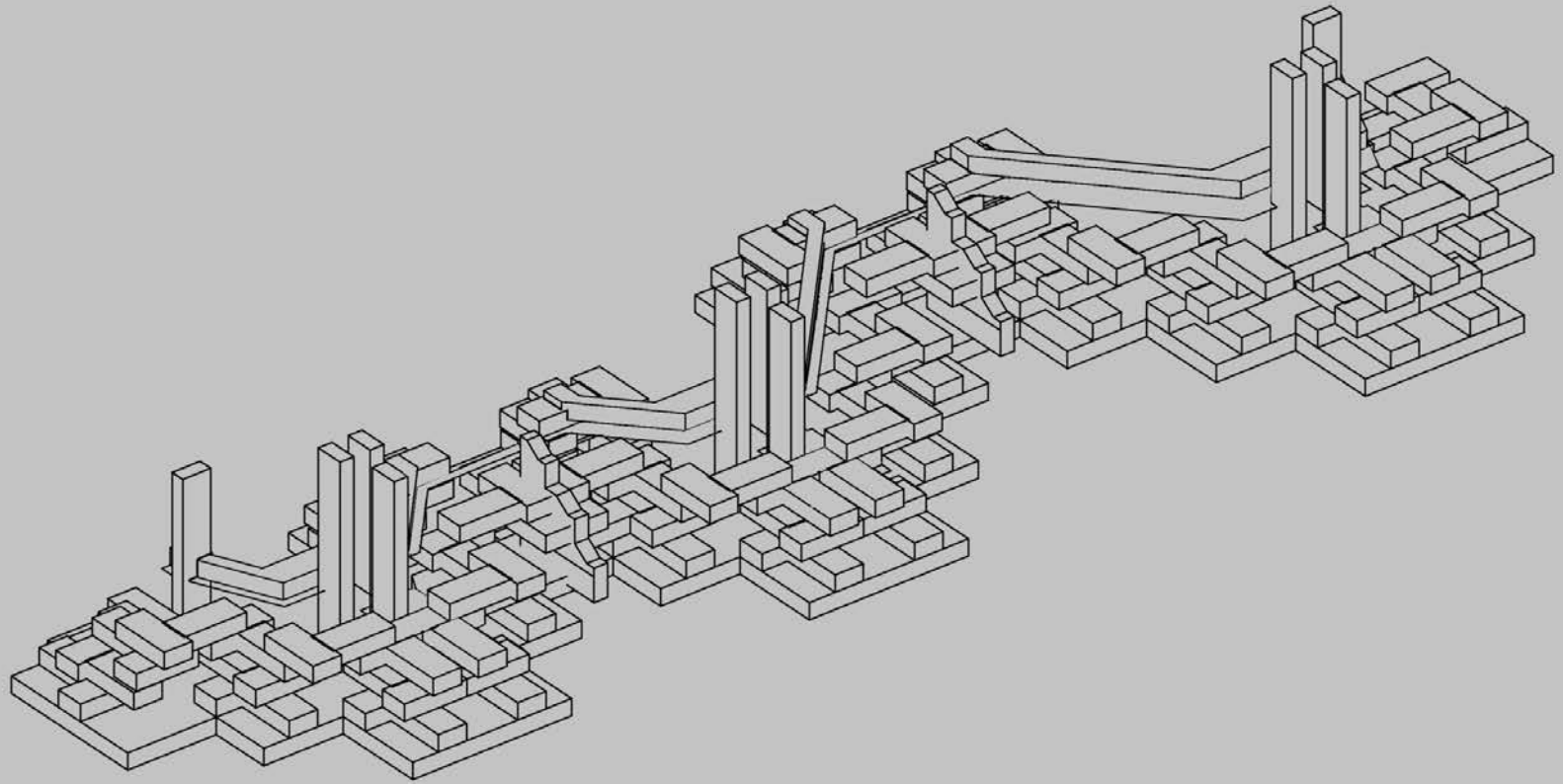

9

# QUINTA PLANTA

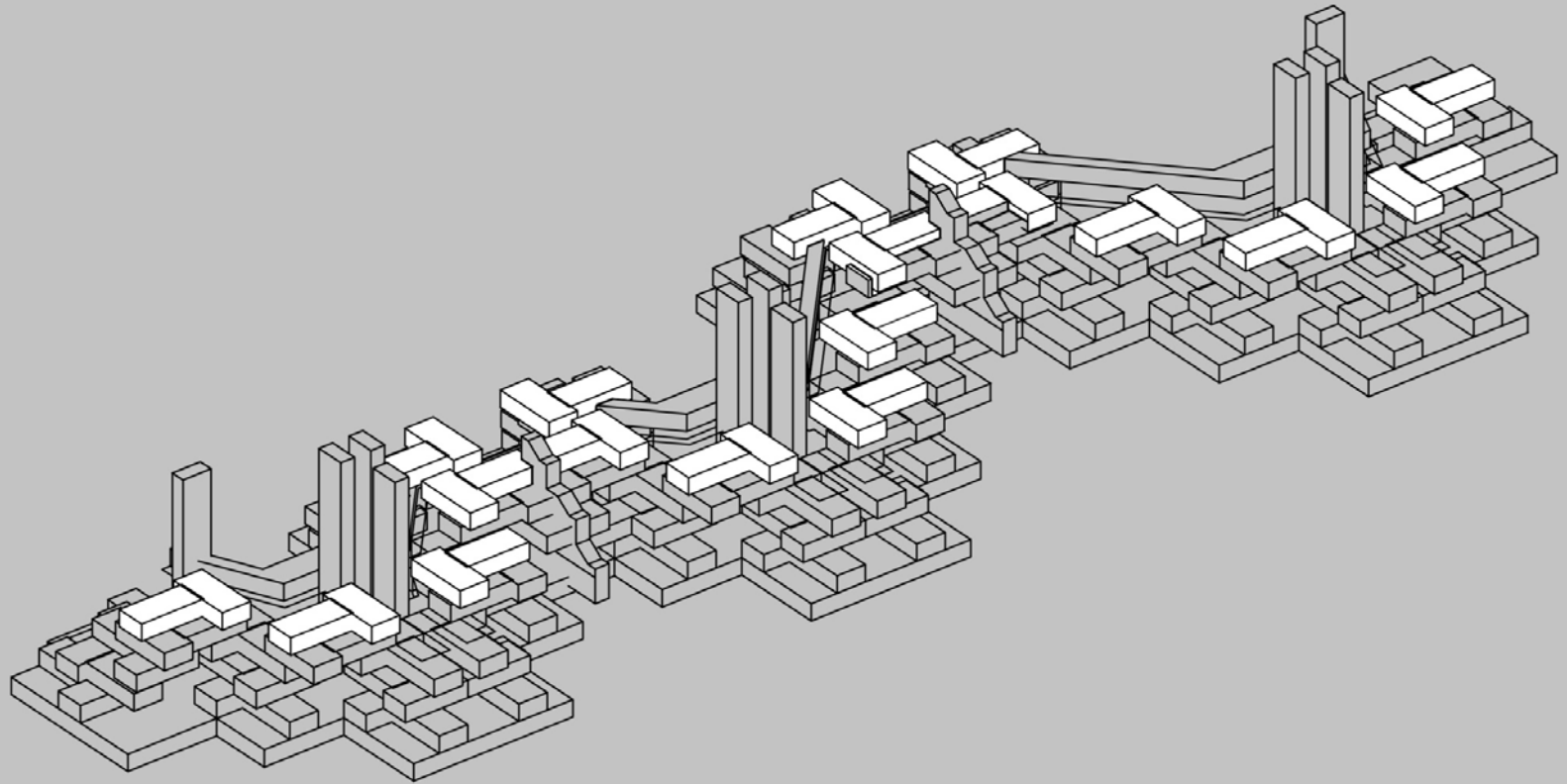

9

# QUINTA PLANTA

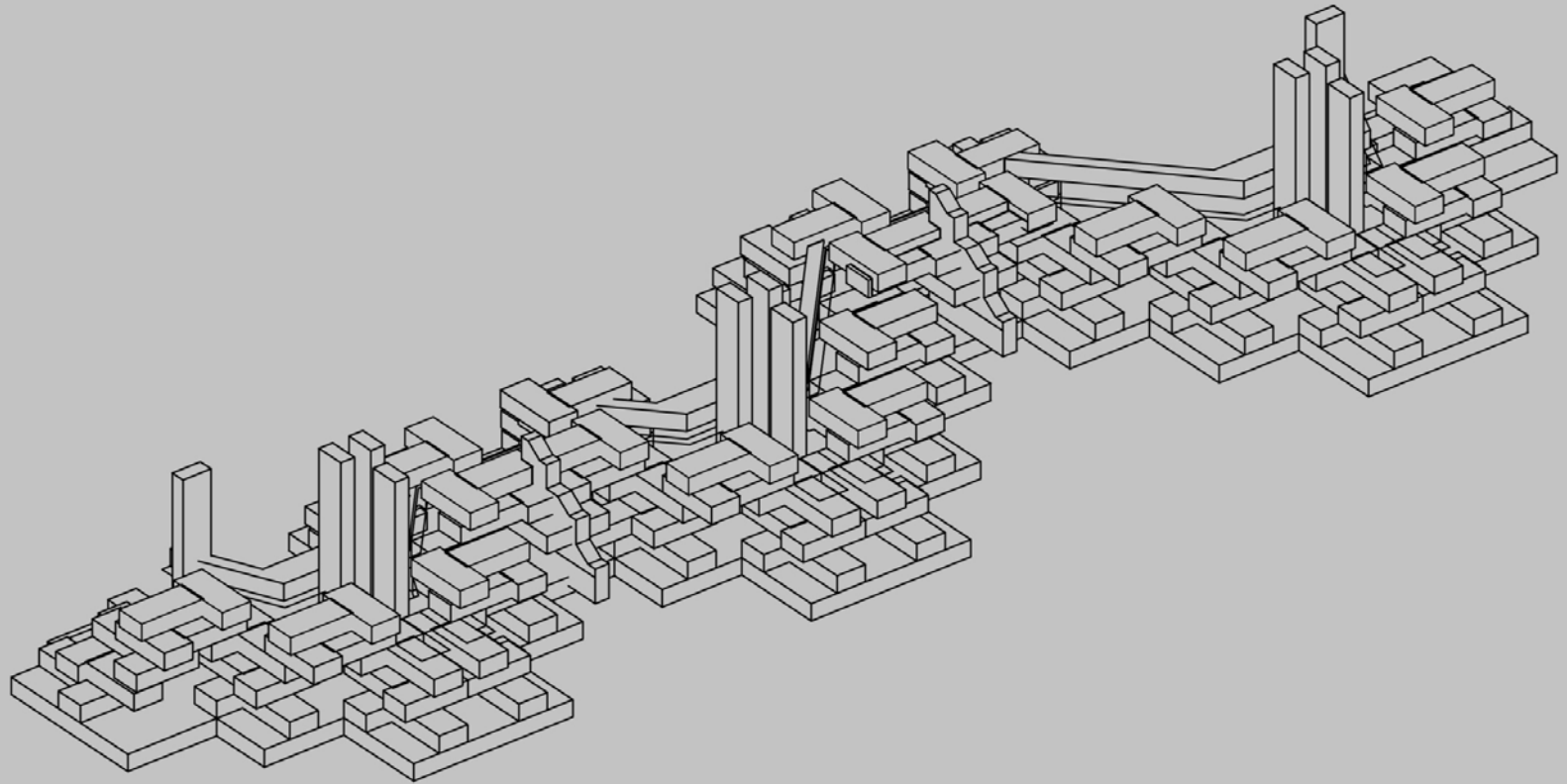

# 10 SEXTA PLANTA

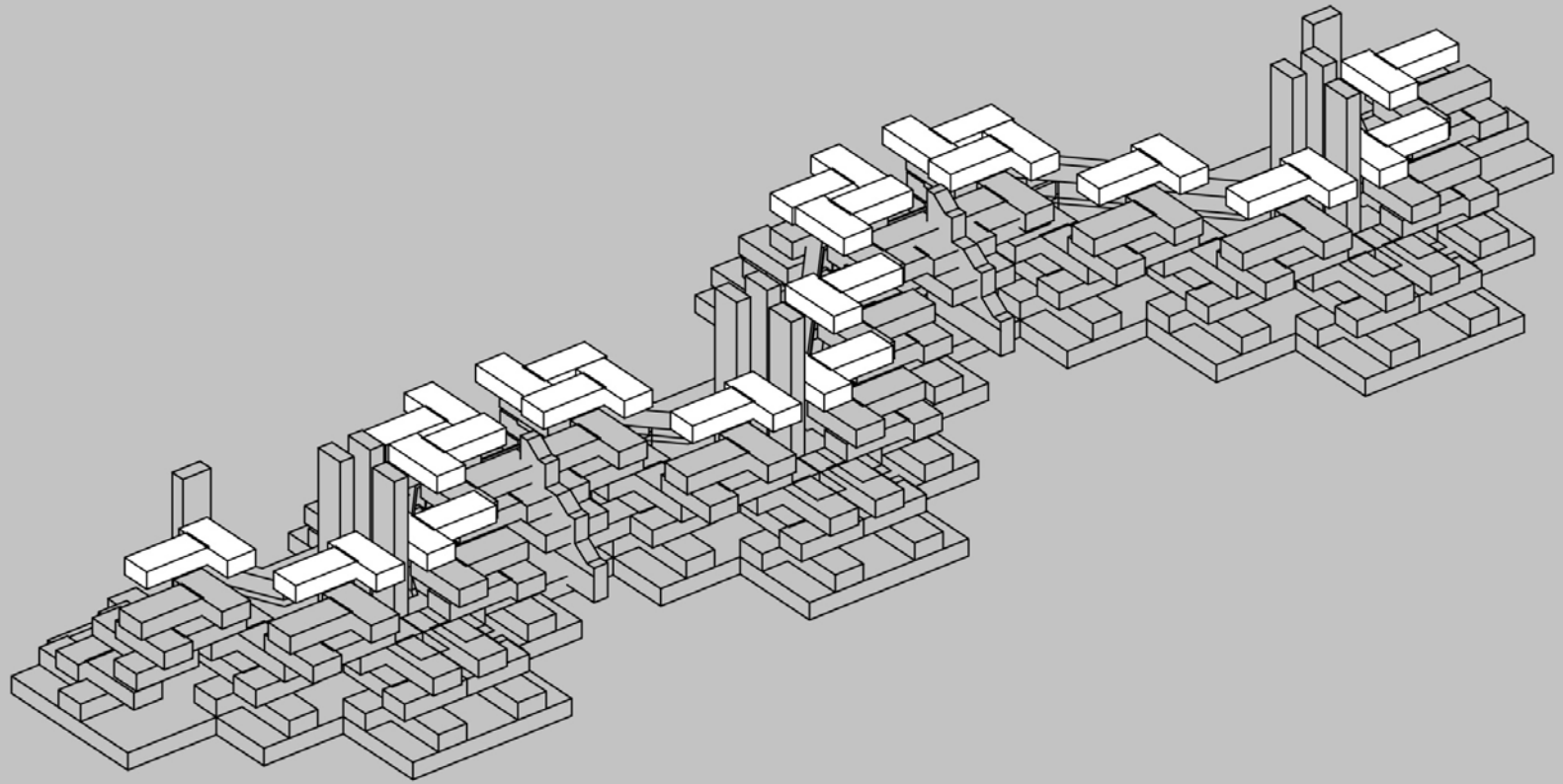

# 10 SEXTA PLANTA

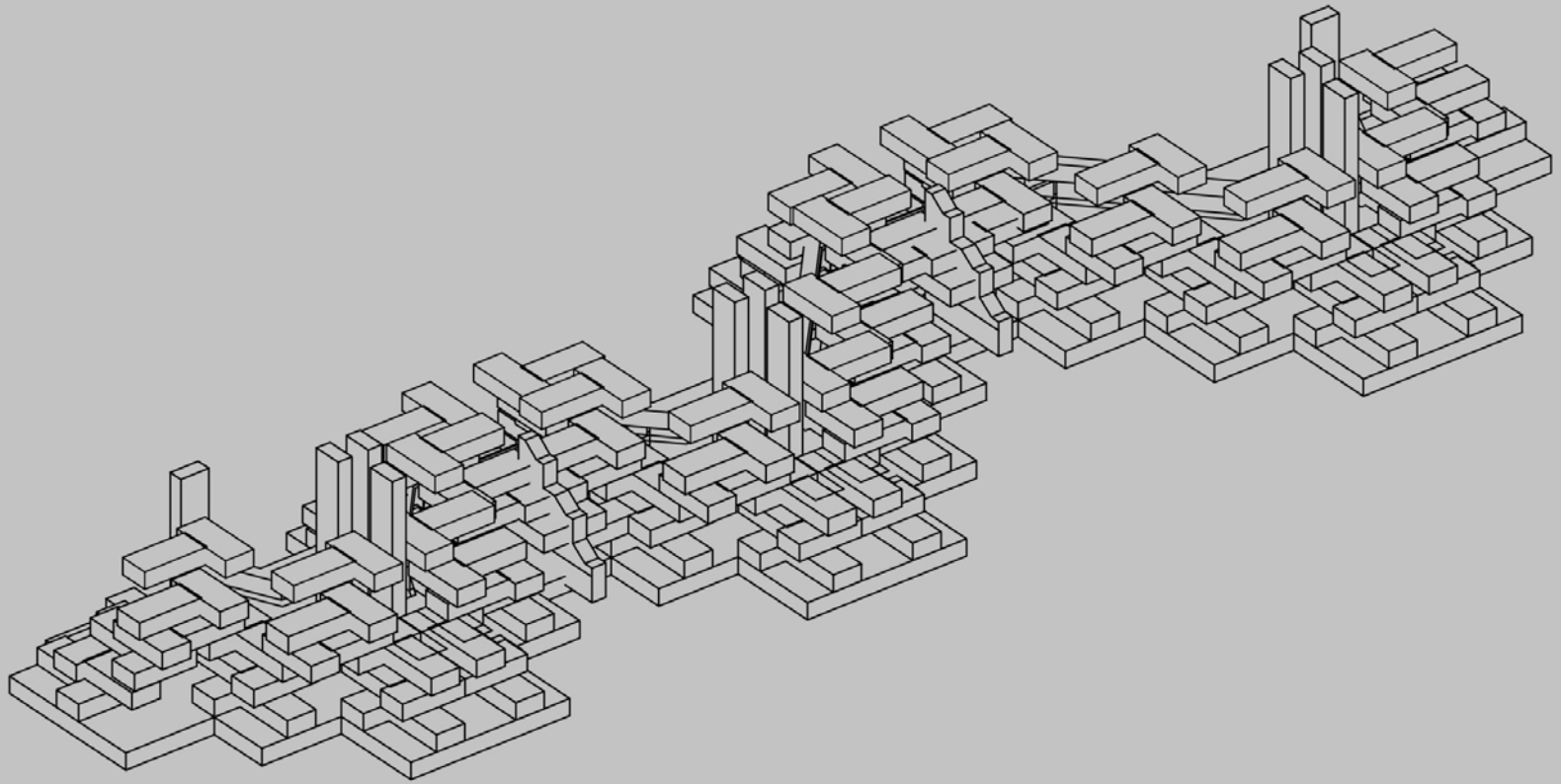

# 11 RECORRIDOS II

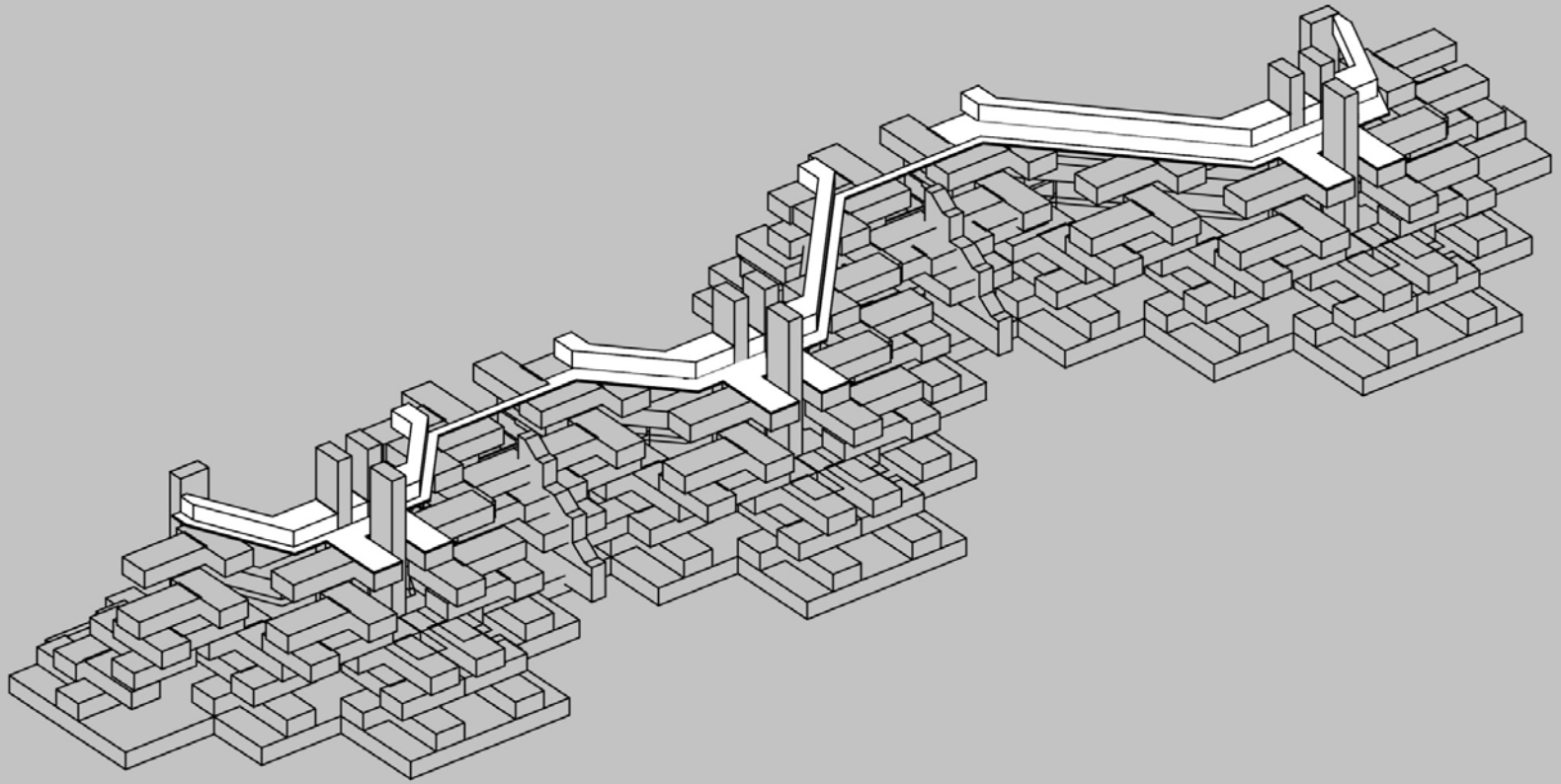

# 11 RECORRIDOS II

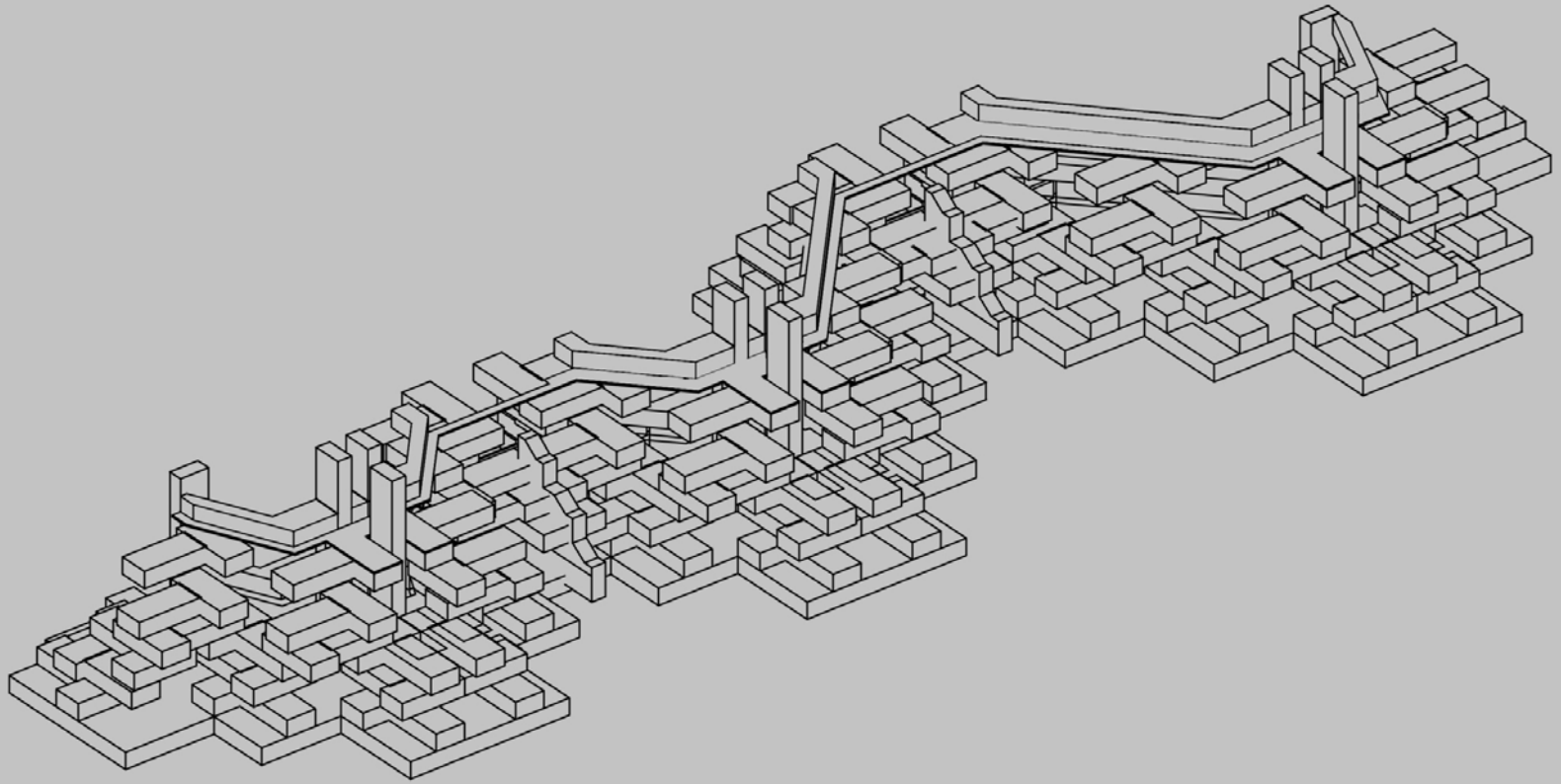

# 12 SÉPTIMA PLANTA

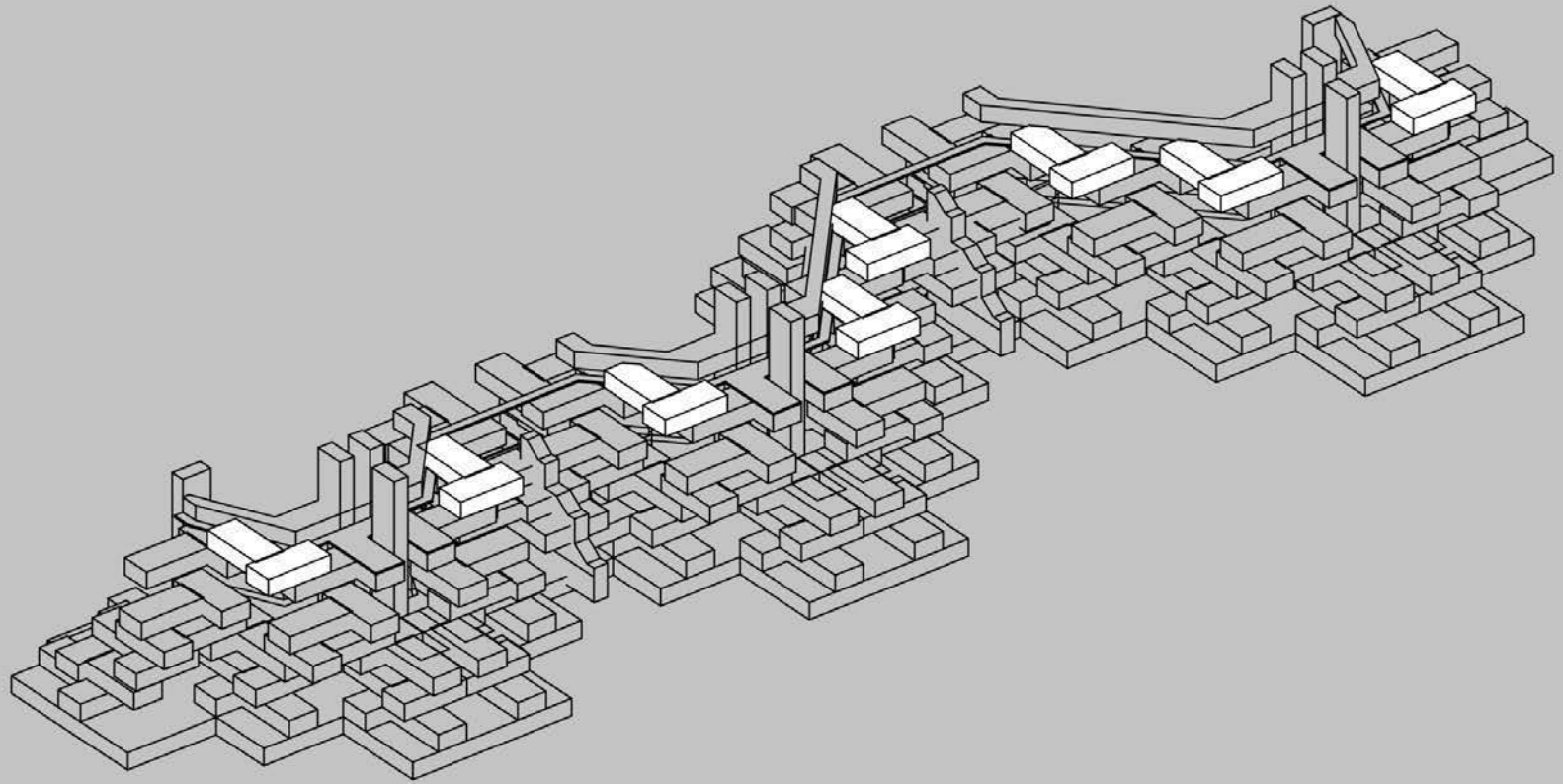



# 12 SÉPTIMA PLANTA

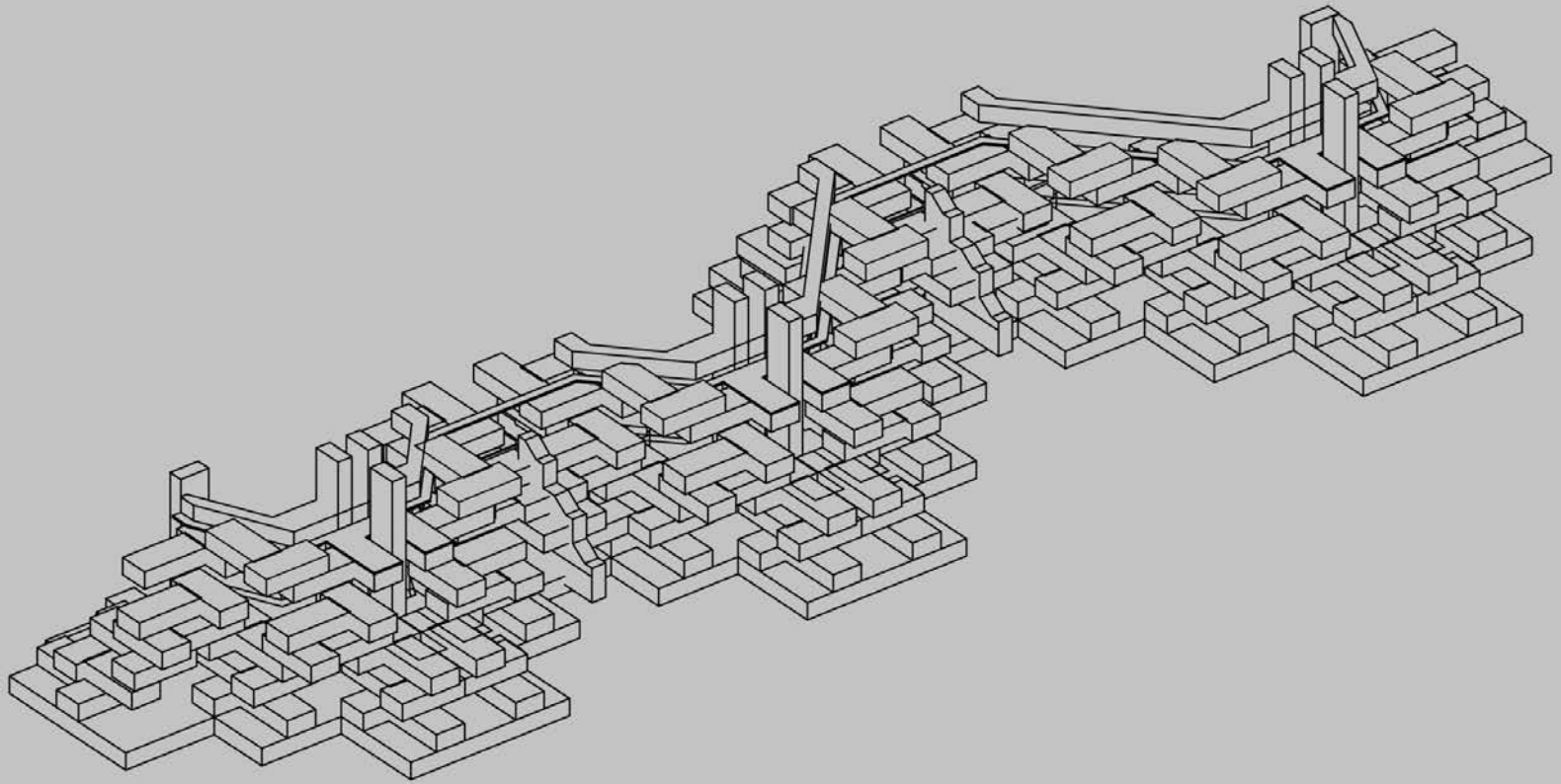

# 13 OCTAVA PLANTA

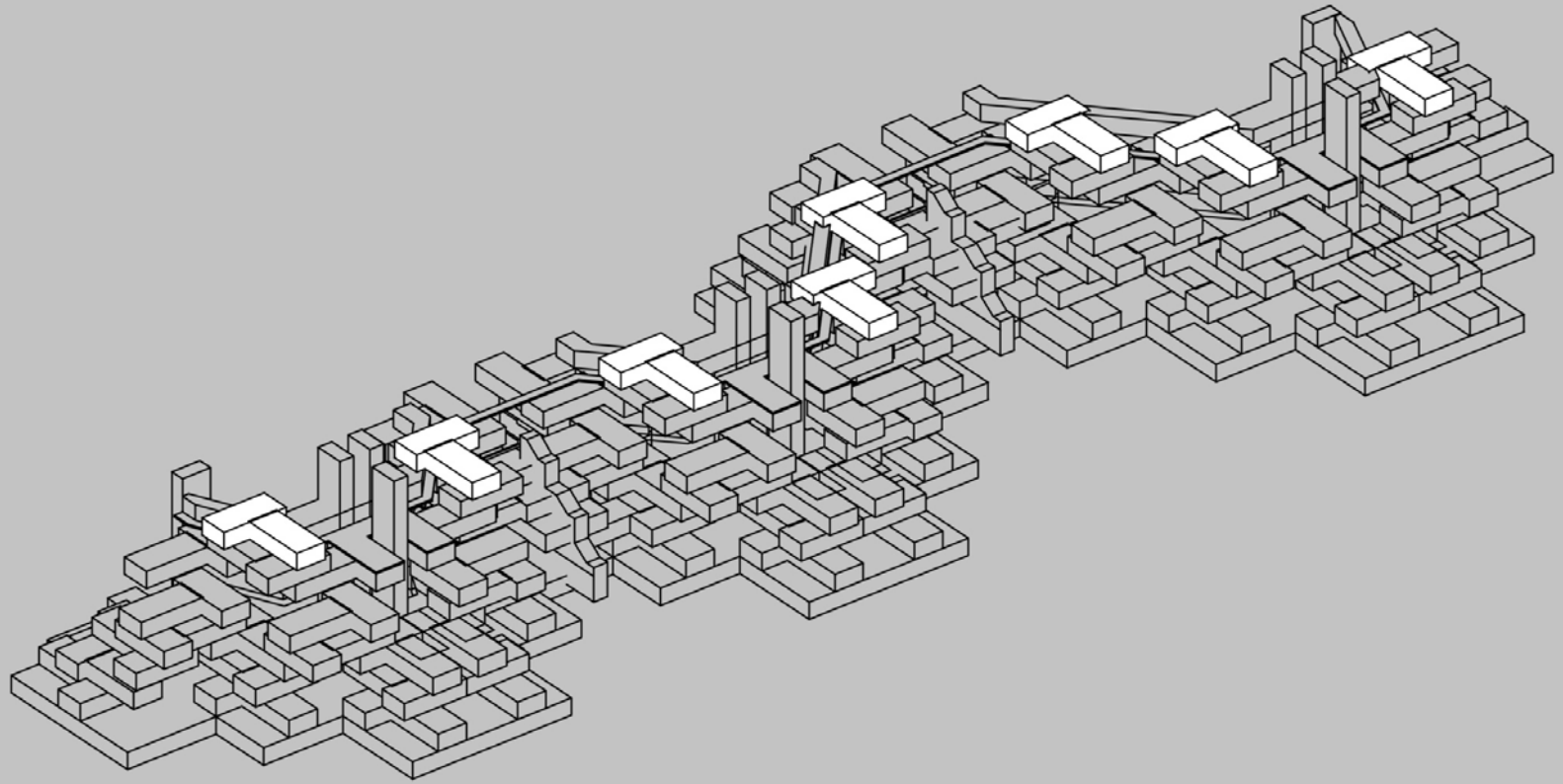

# 13 OCTAVA PLANTA

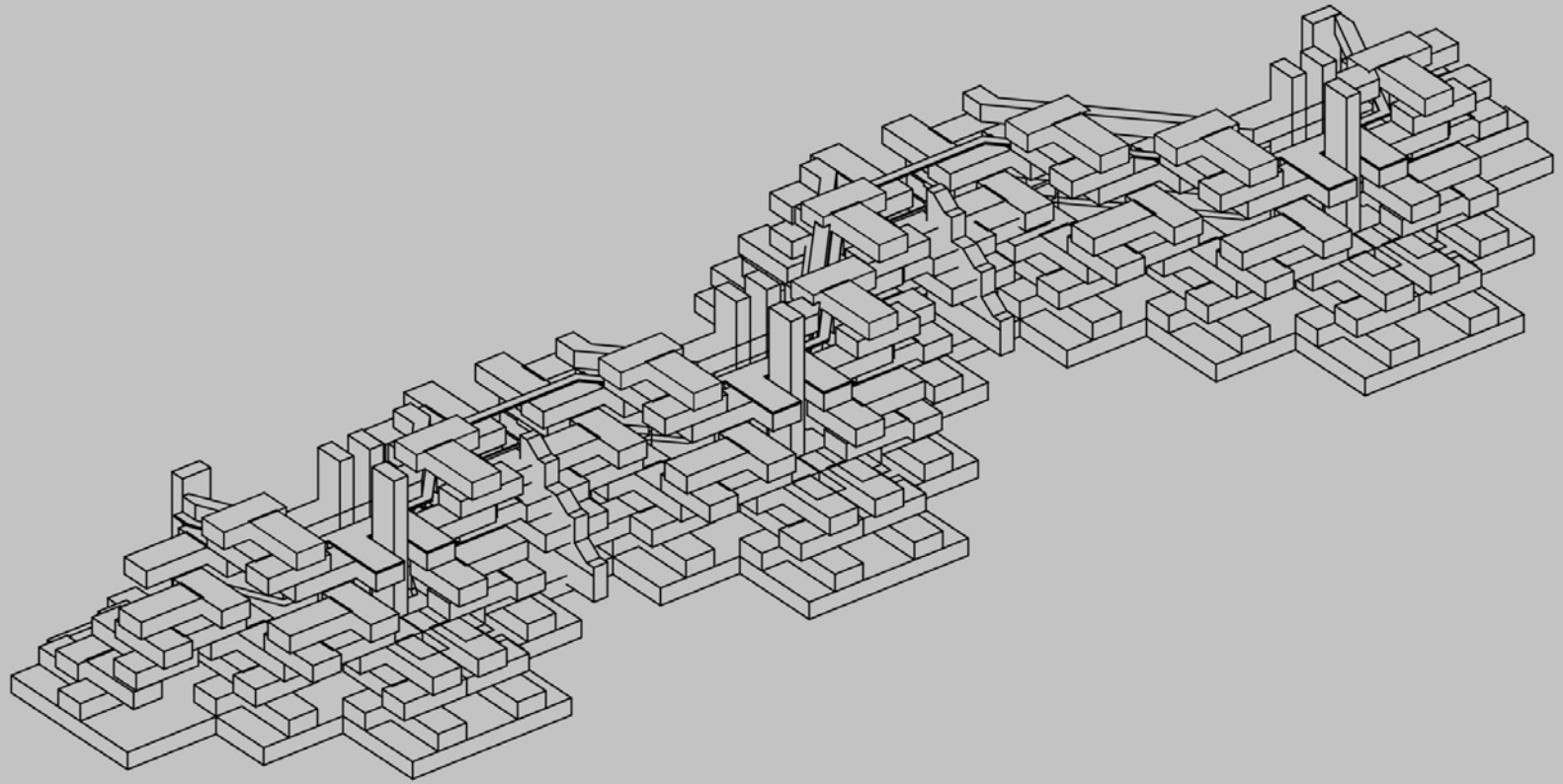

# 14 NOVENA PLANTA

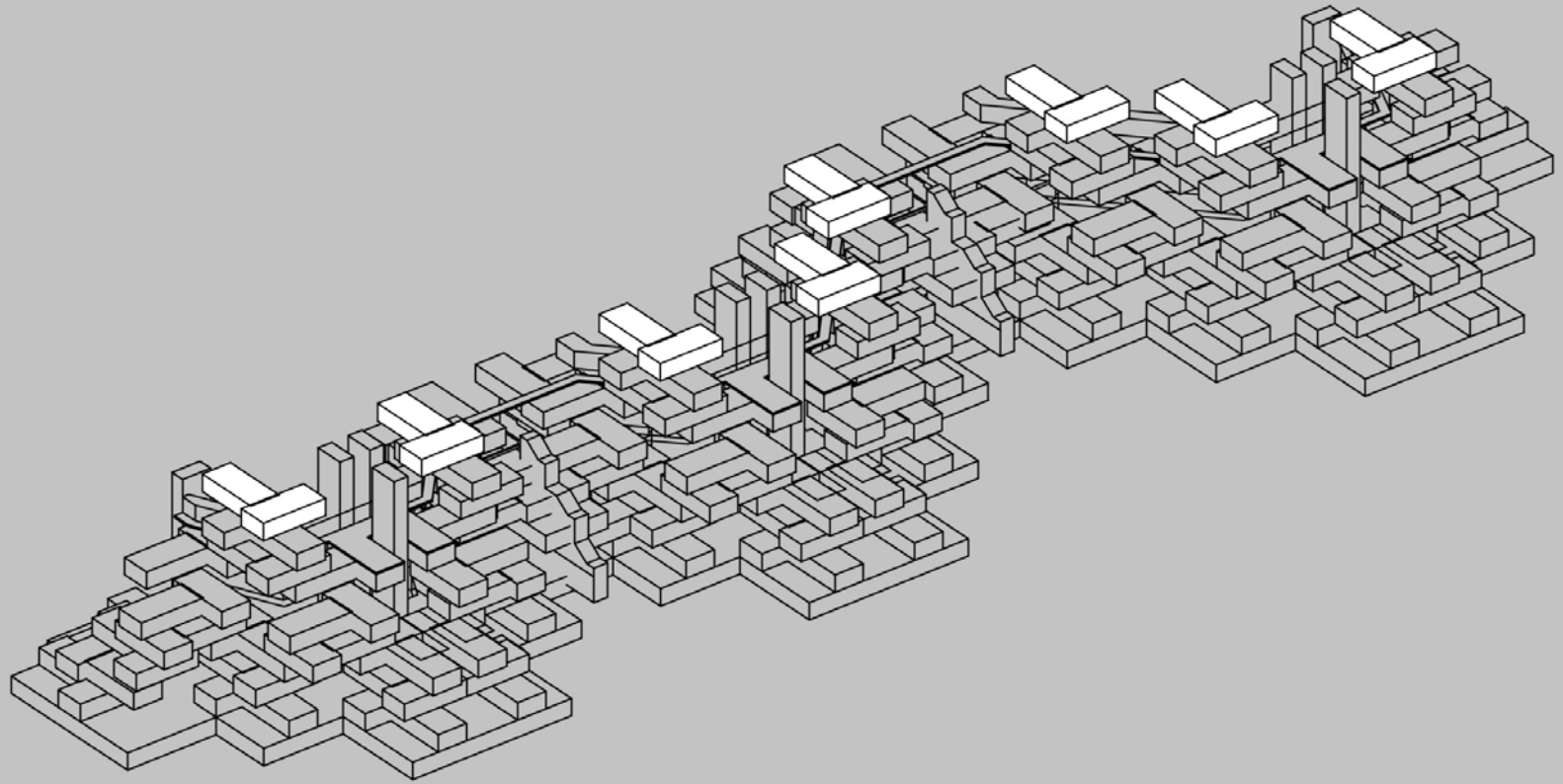

# 14 NOVENA PLANTA

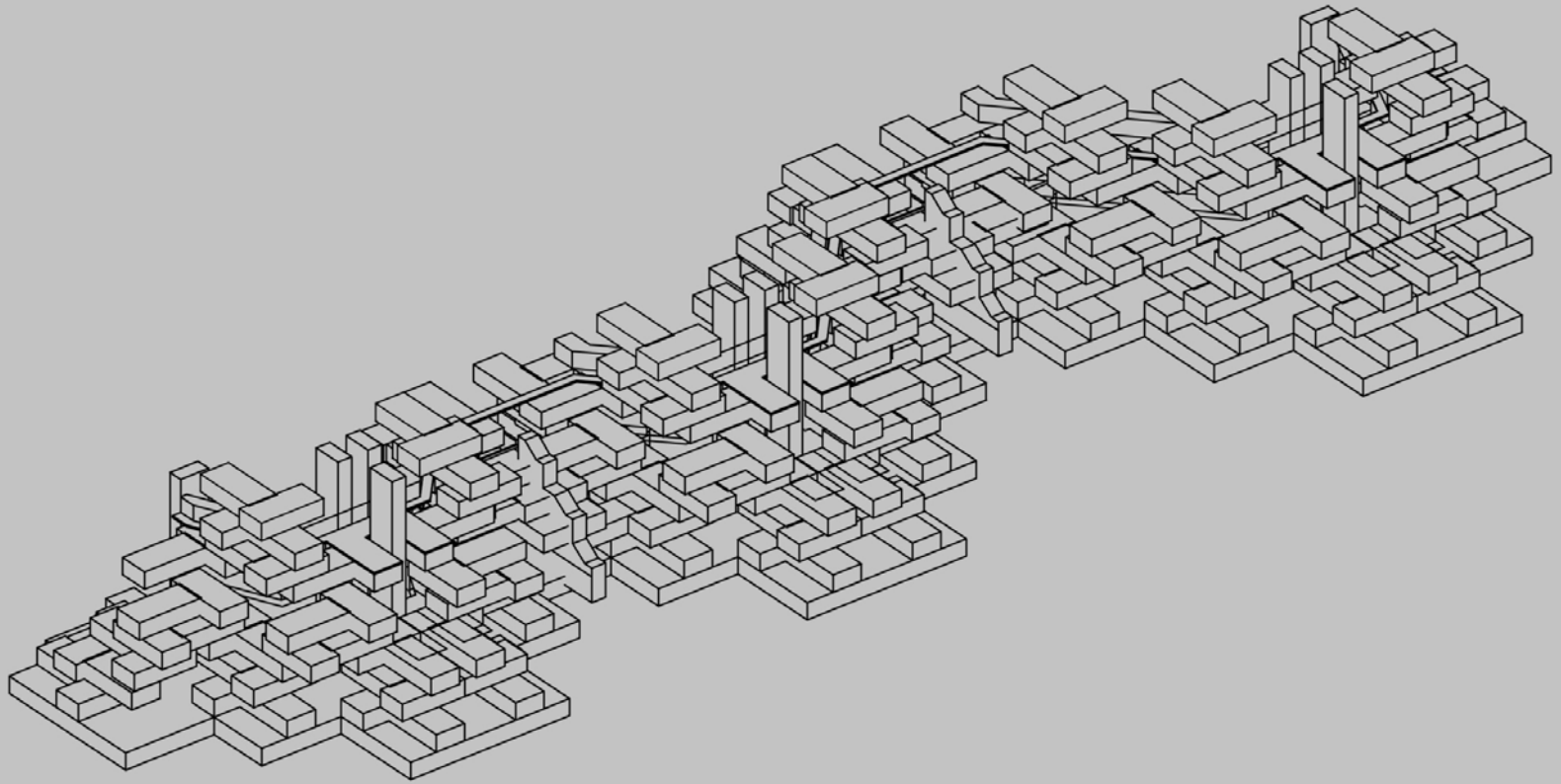

# 15 DÉCIMA PLANTA

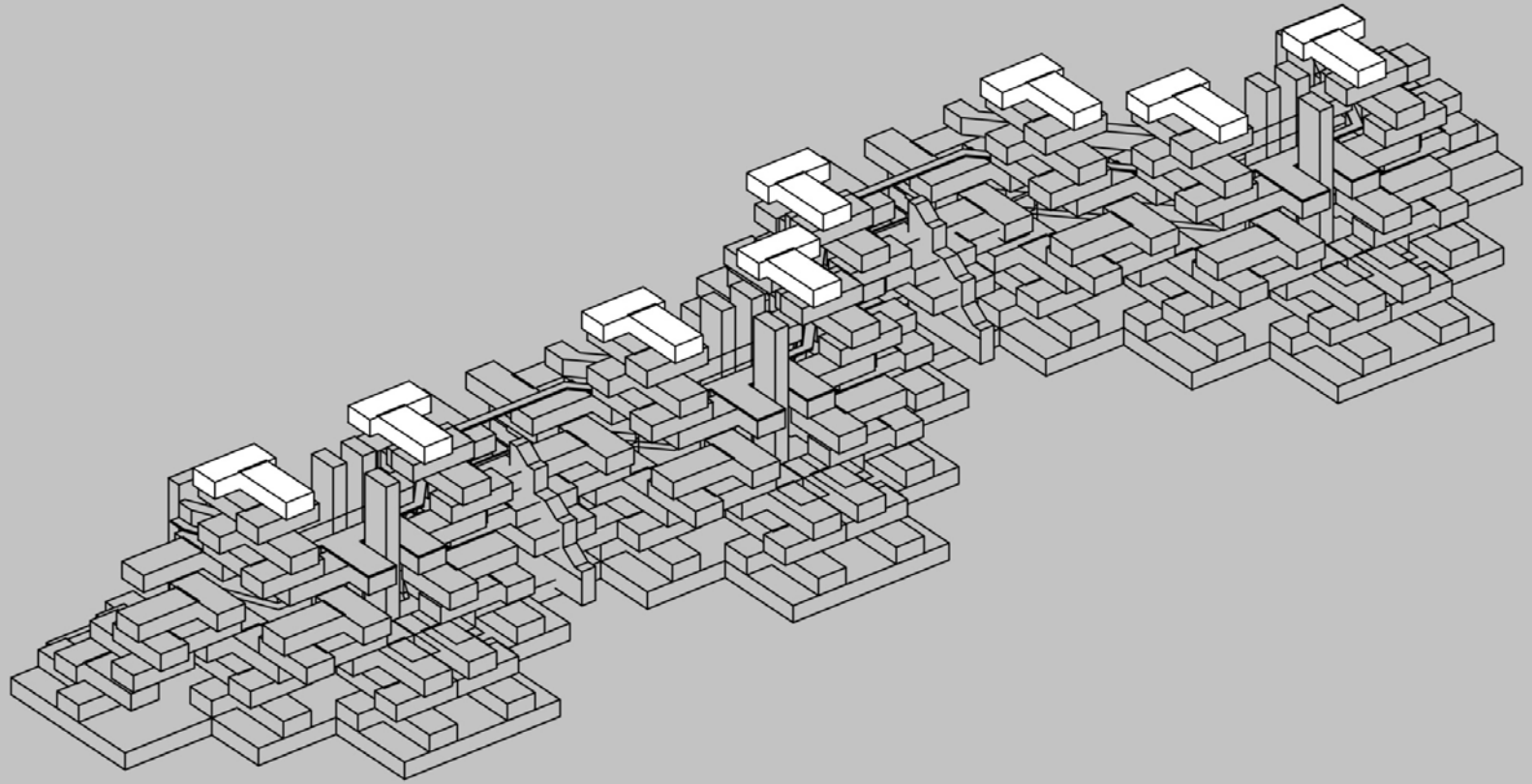

16 CONJUNTO

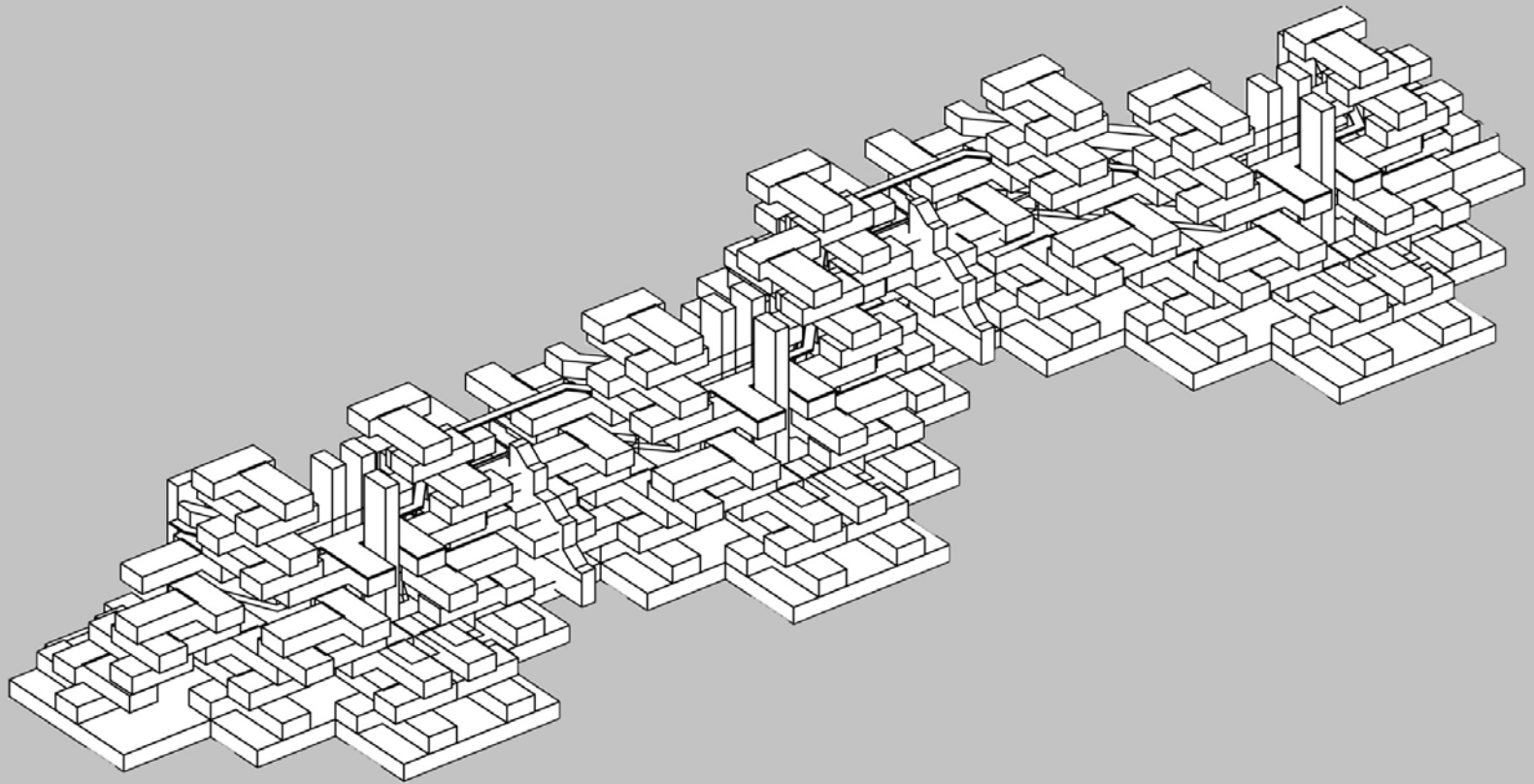

# C ONSTRUCCIÓN





1

# UNIDAD DE PREFABRICACIÓN



1

# UNIDAD DE PREFABRICACIÓN

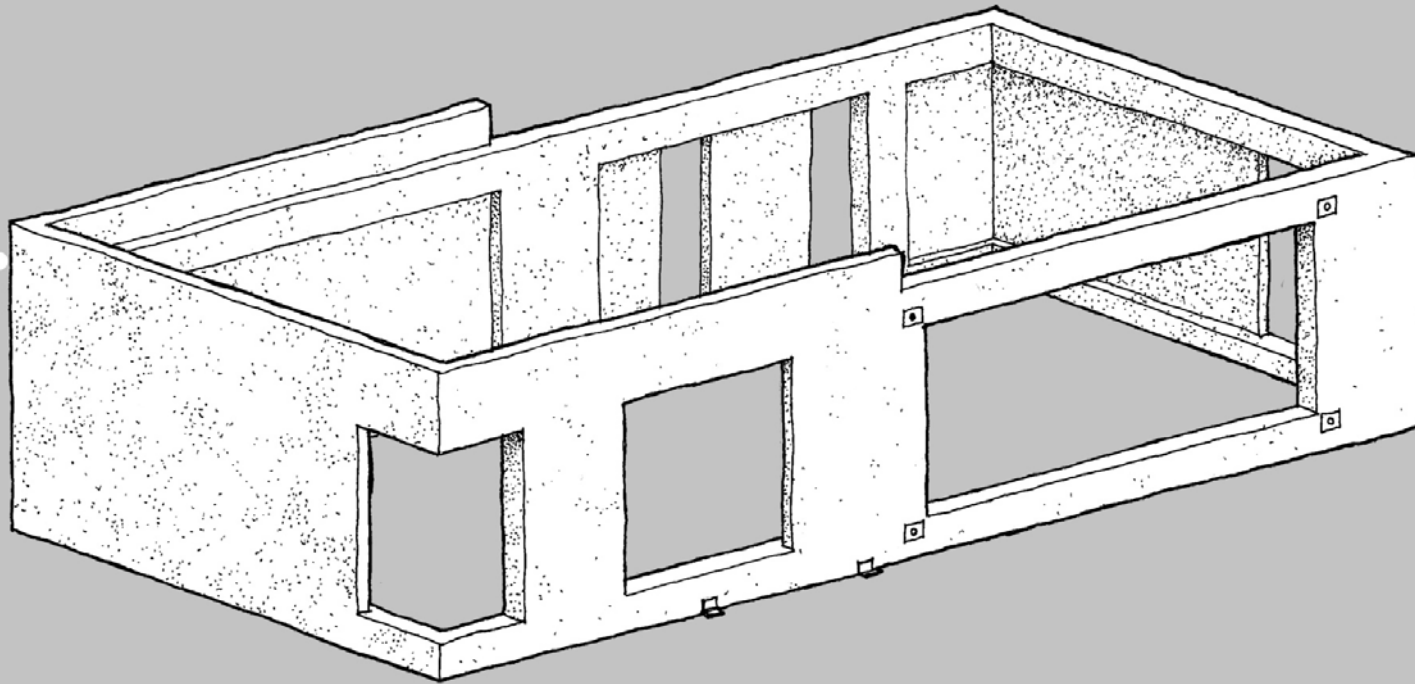

1

# UNIDAD DE PREFABRICACIÓN

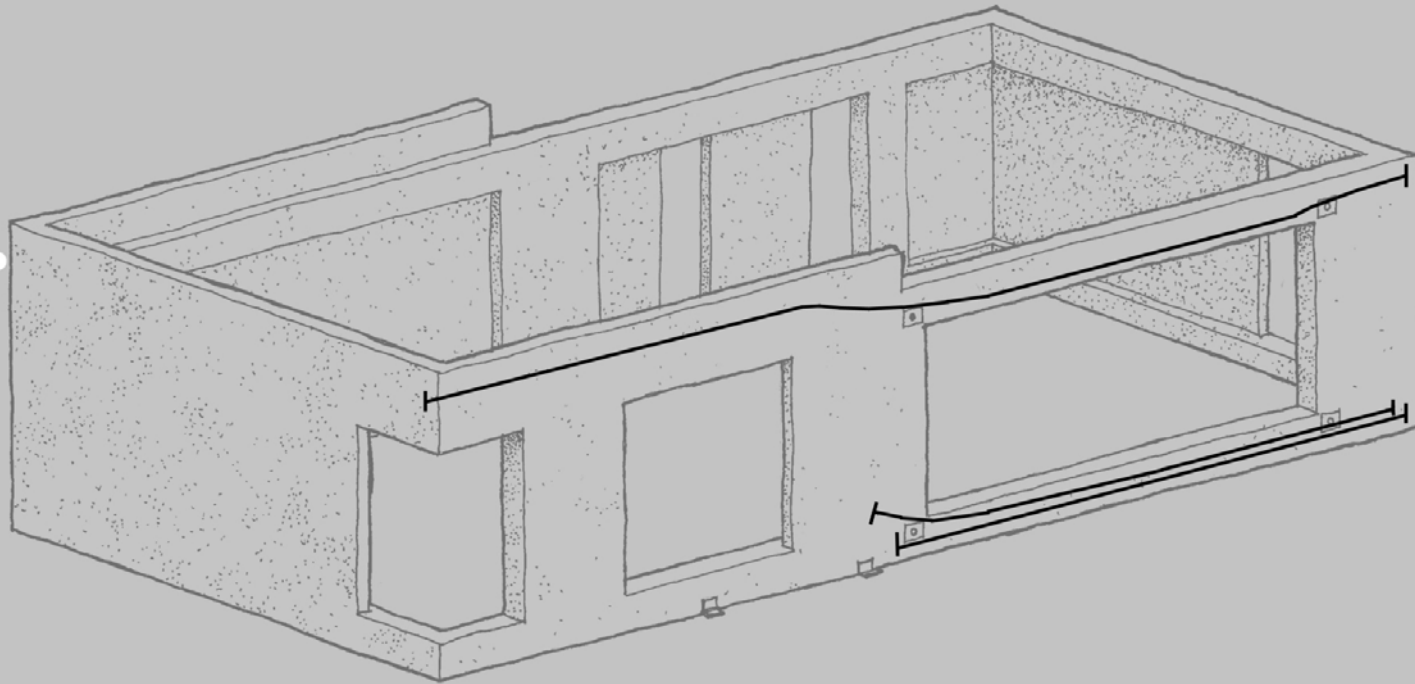

1

# UNIDAD DE PREFABRICACIÓN

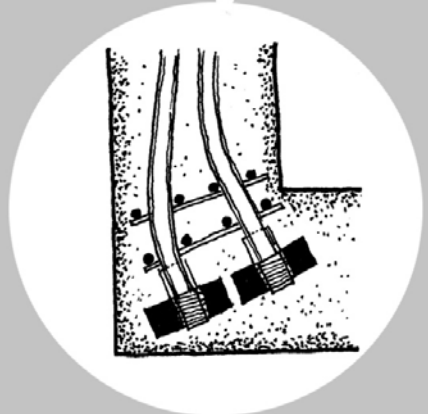
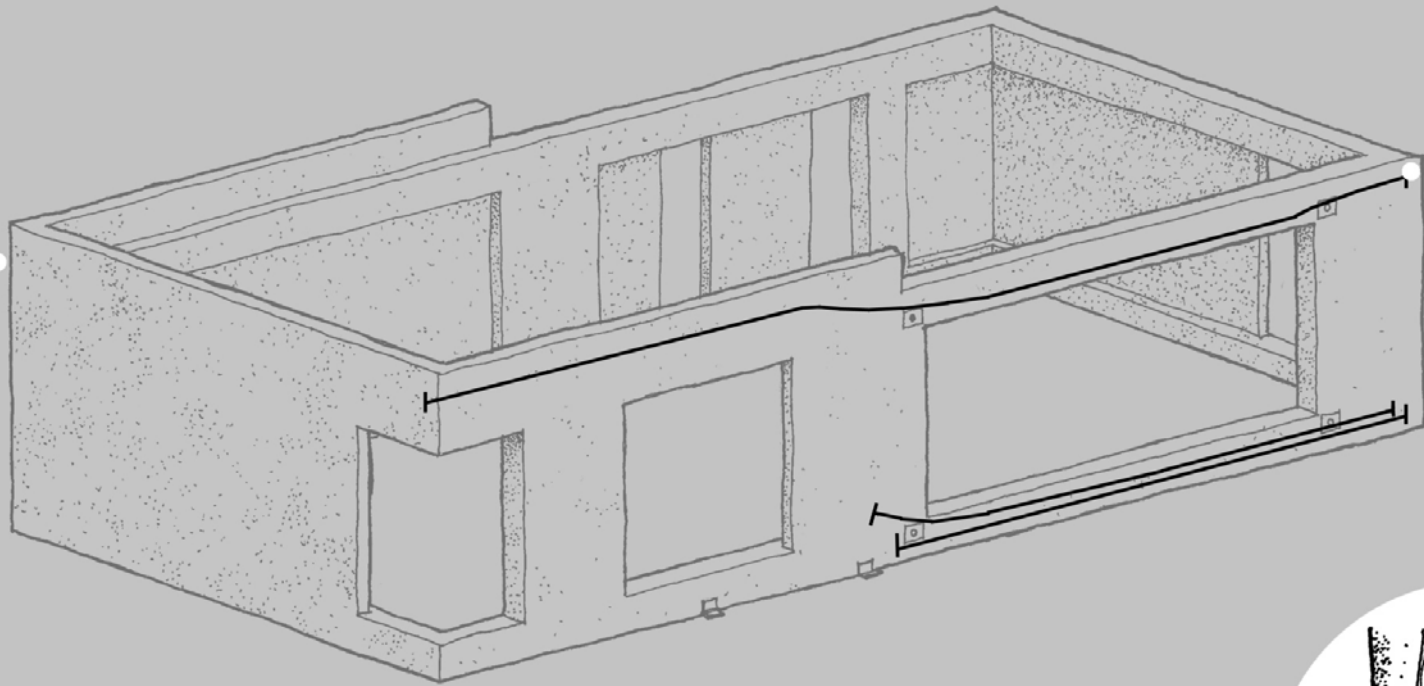

1

# UNIDAD DE PREFABRICACIÓN

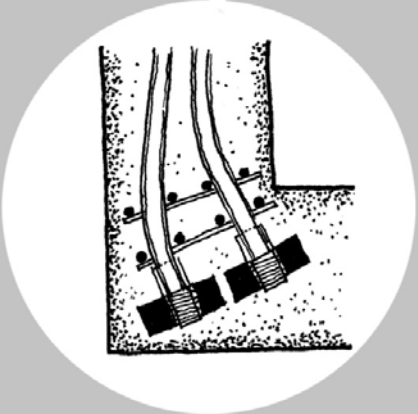
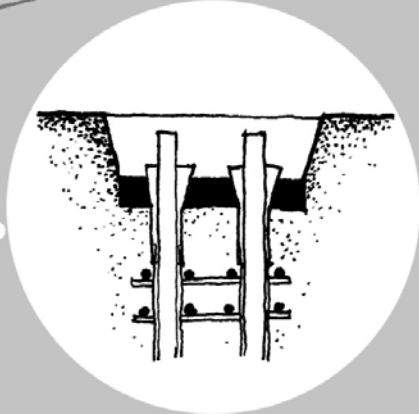
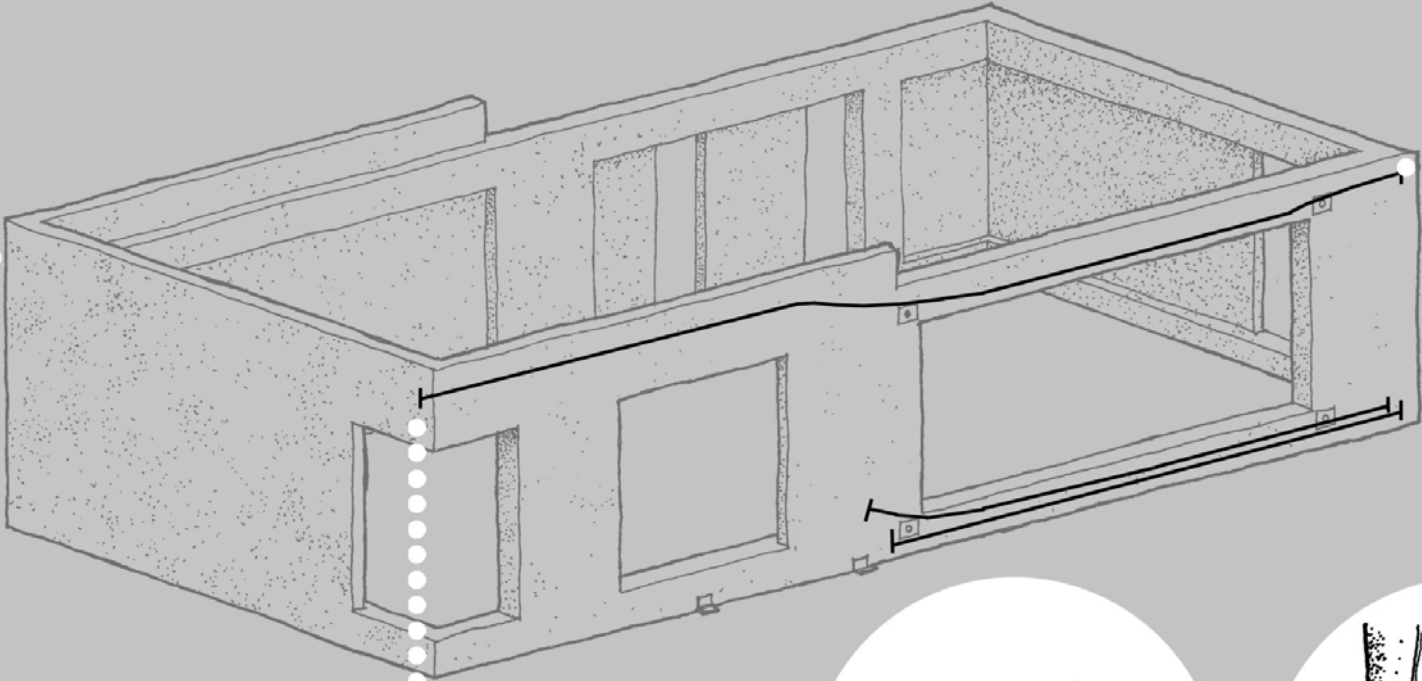

# 2 UNIDAD DE TRABAJO



2

## UNIDAD DE TRABAJO

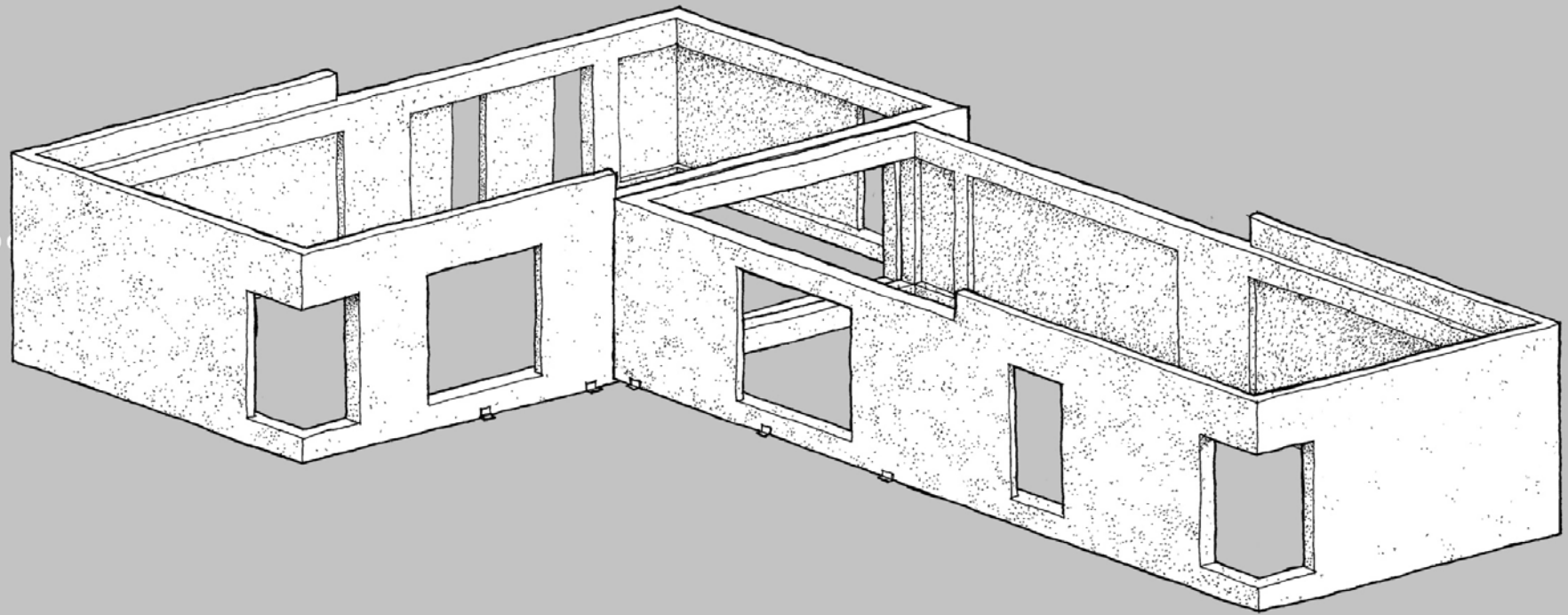

2

## UNIDAD DE TRABAJO

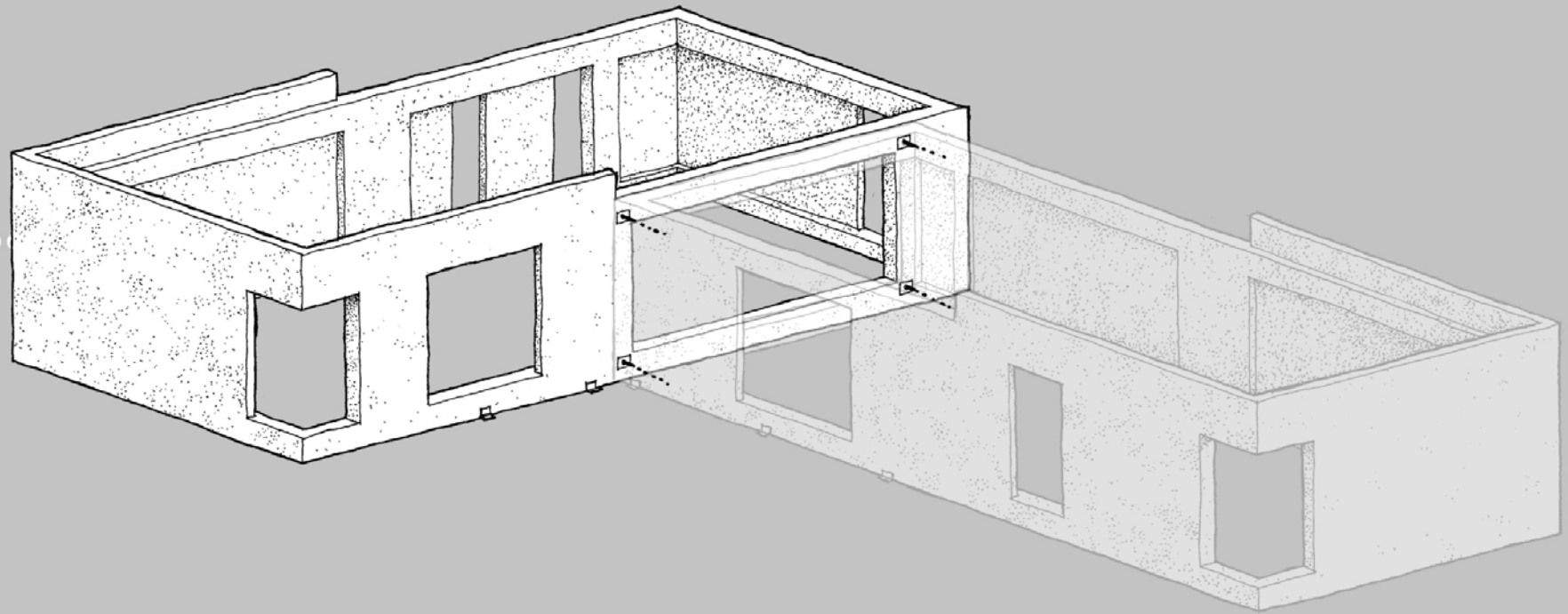



2

# UNIDAD DE TRABAJO

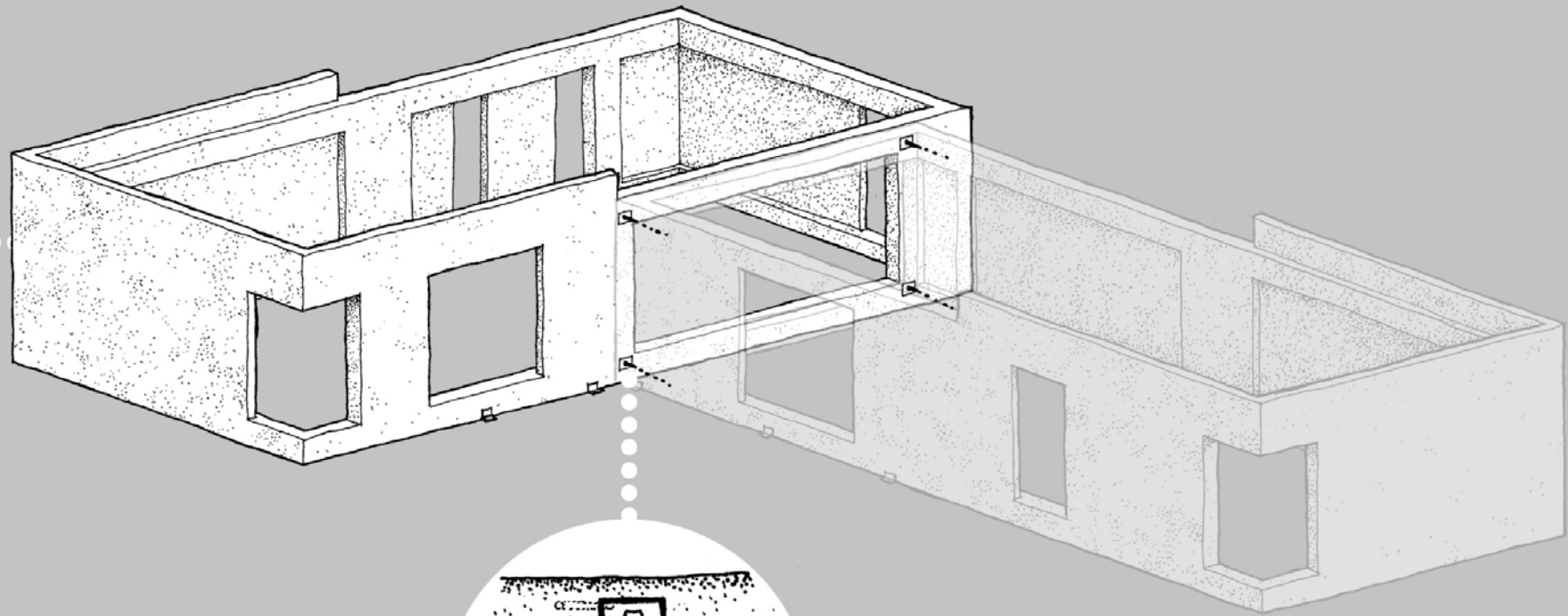

3

## MECANISMOS DE COMPOSICIÓN



3

## MECANISMOS DE COMPOSICIÓN

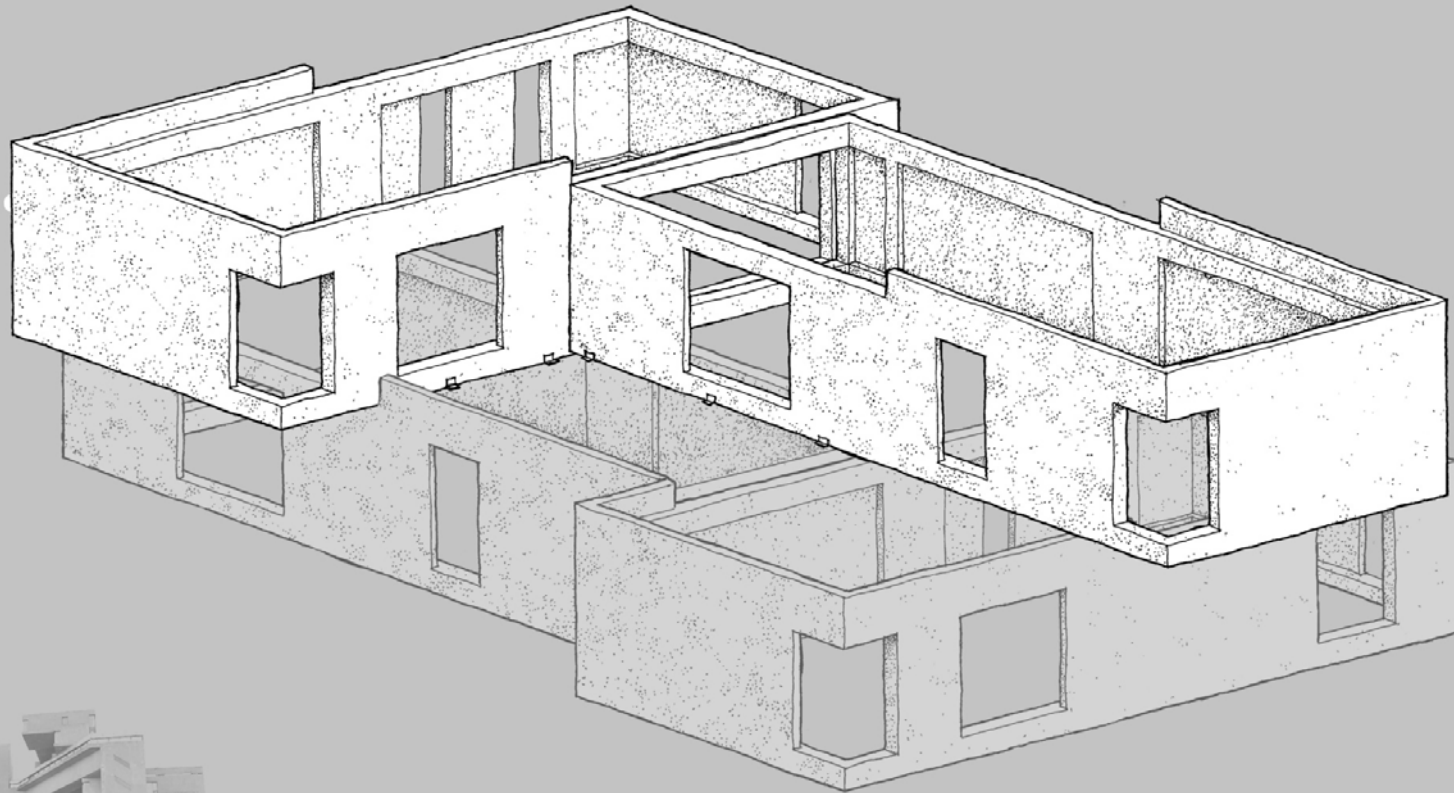

3

# MECANISMOS DE COMPOSICIÓN

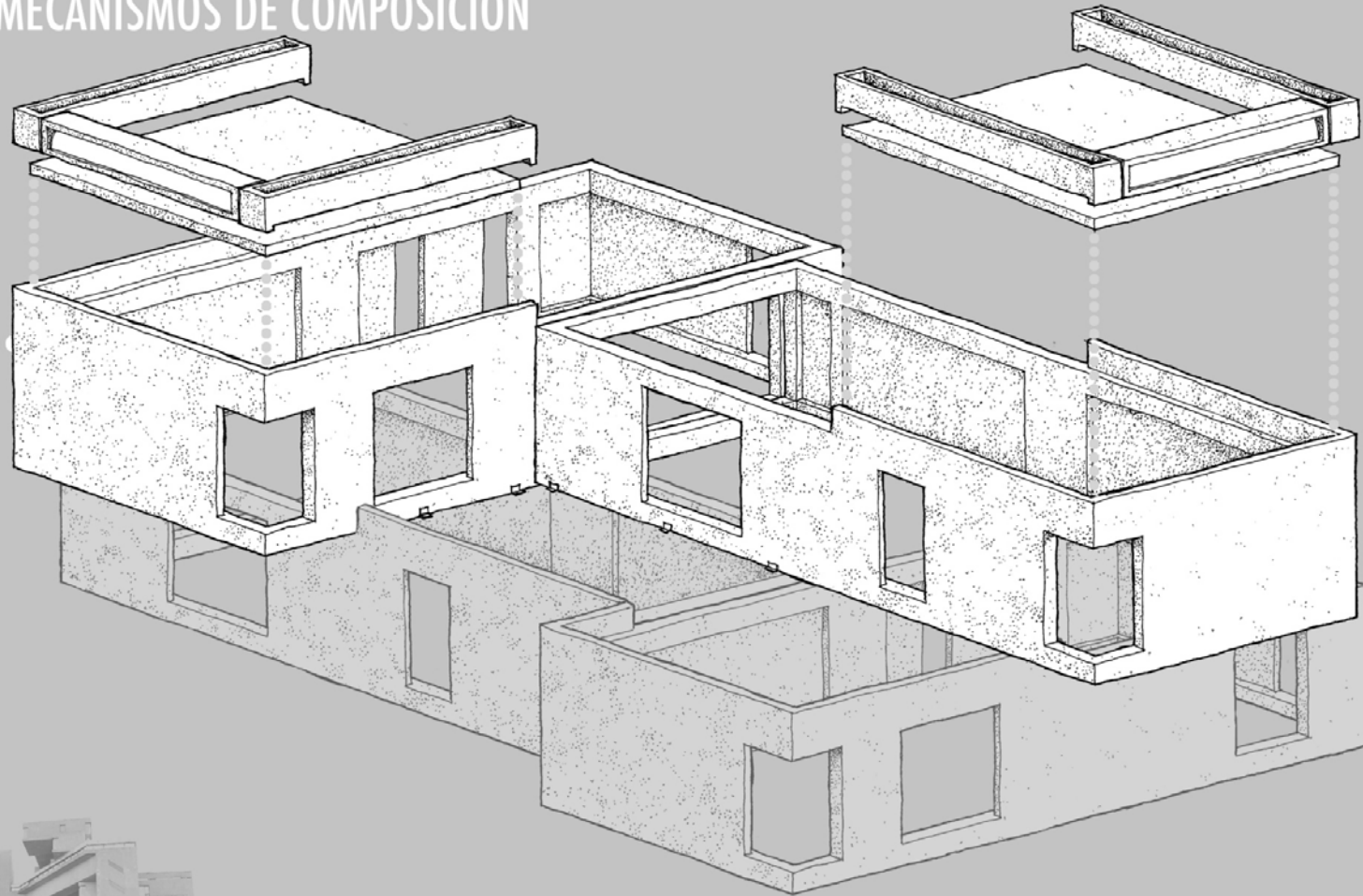

3

## MECANISMOS DE COMPOSICIÓN

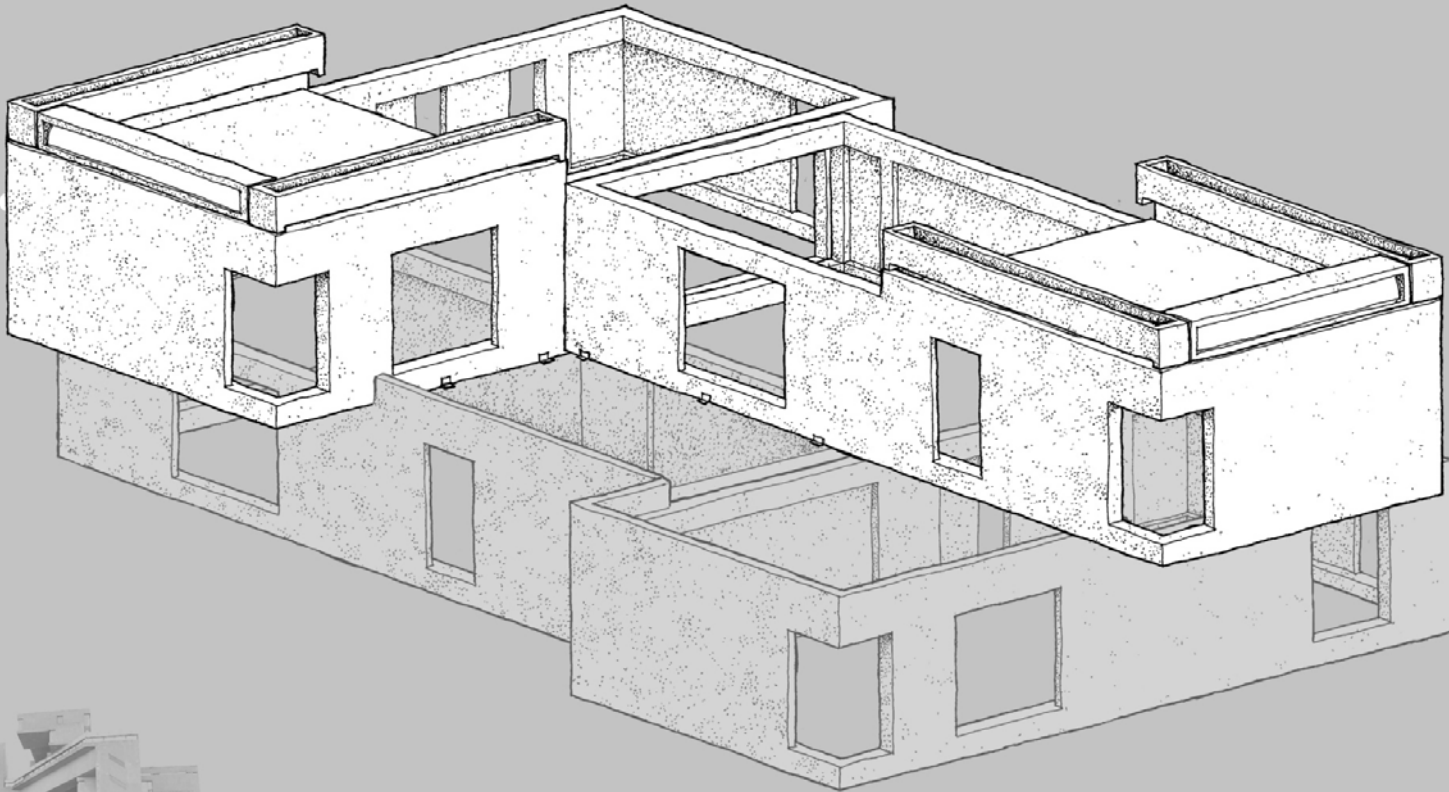

3

## MECANISMOS DE COMPOSICIÓN

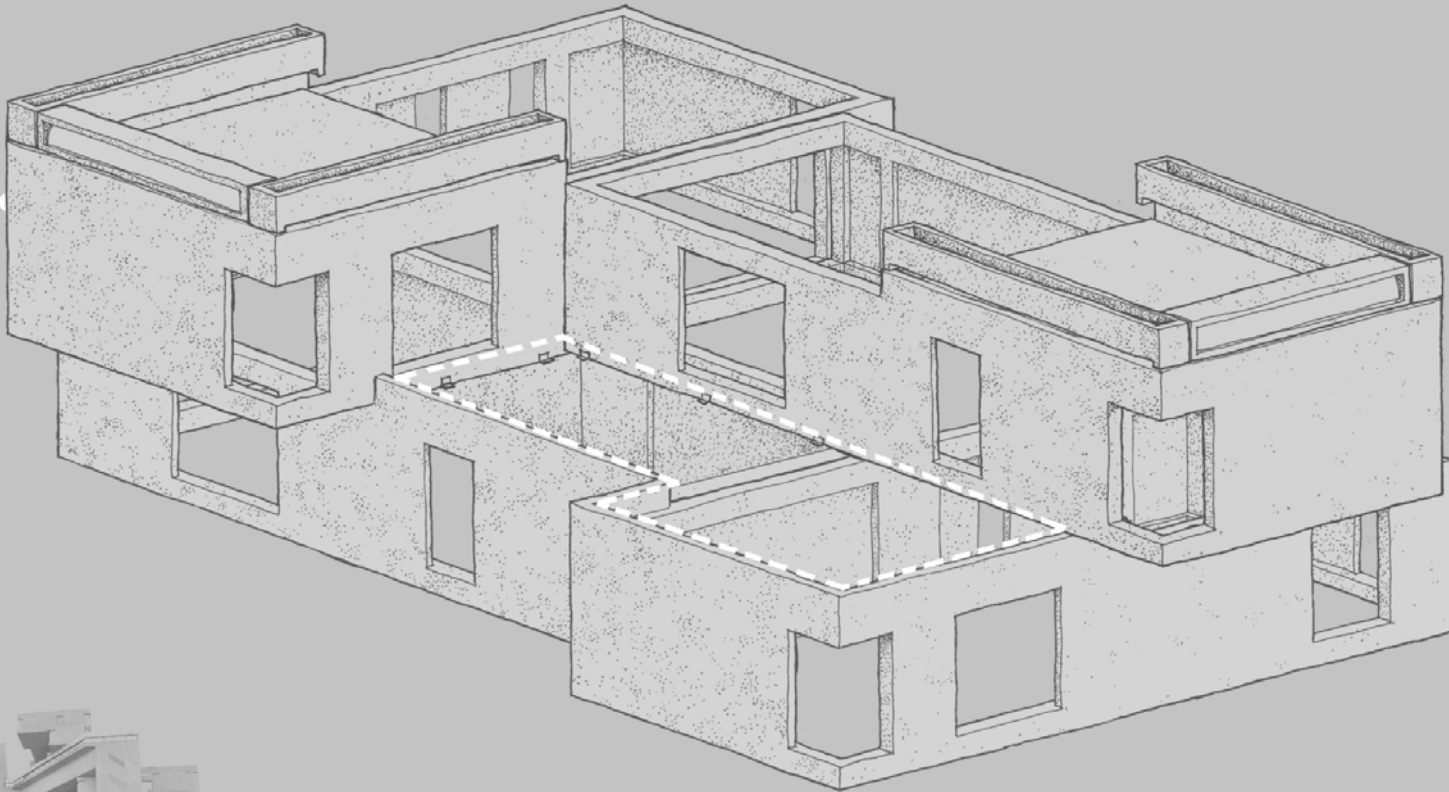

3

# MECANISMOS DE COMPOSICIÓN

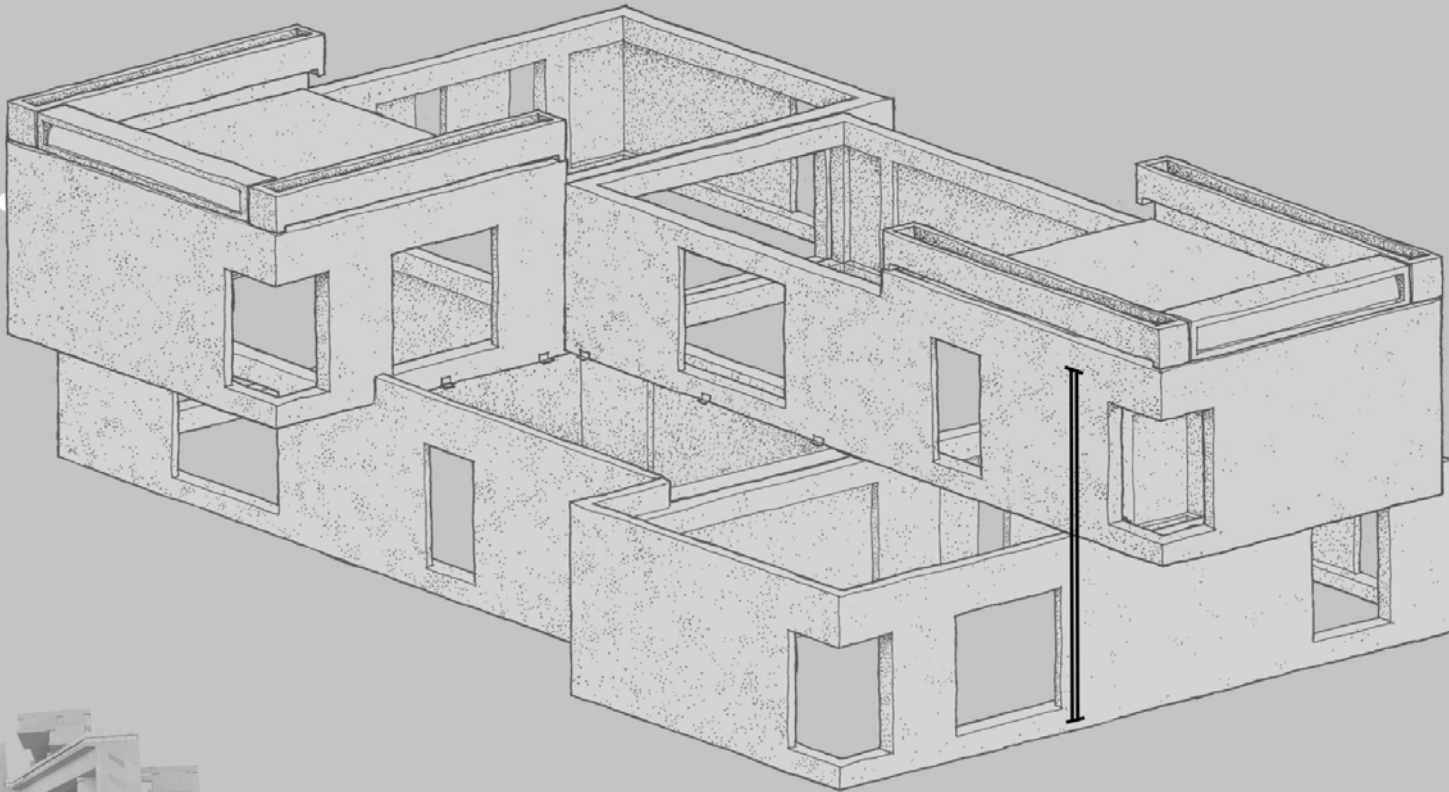

3

# MECANISMOS DE COMPOSICIÓN

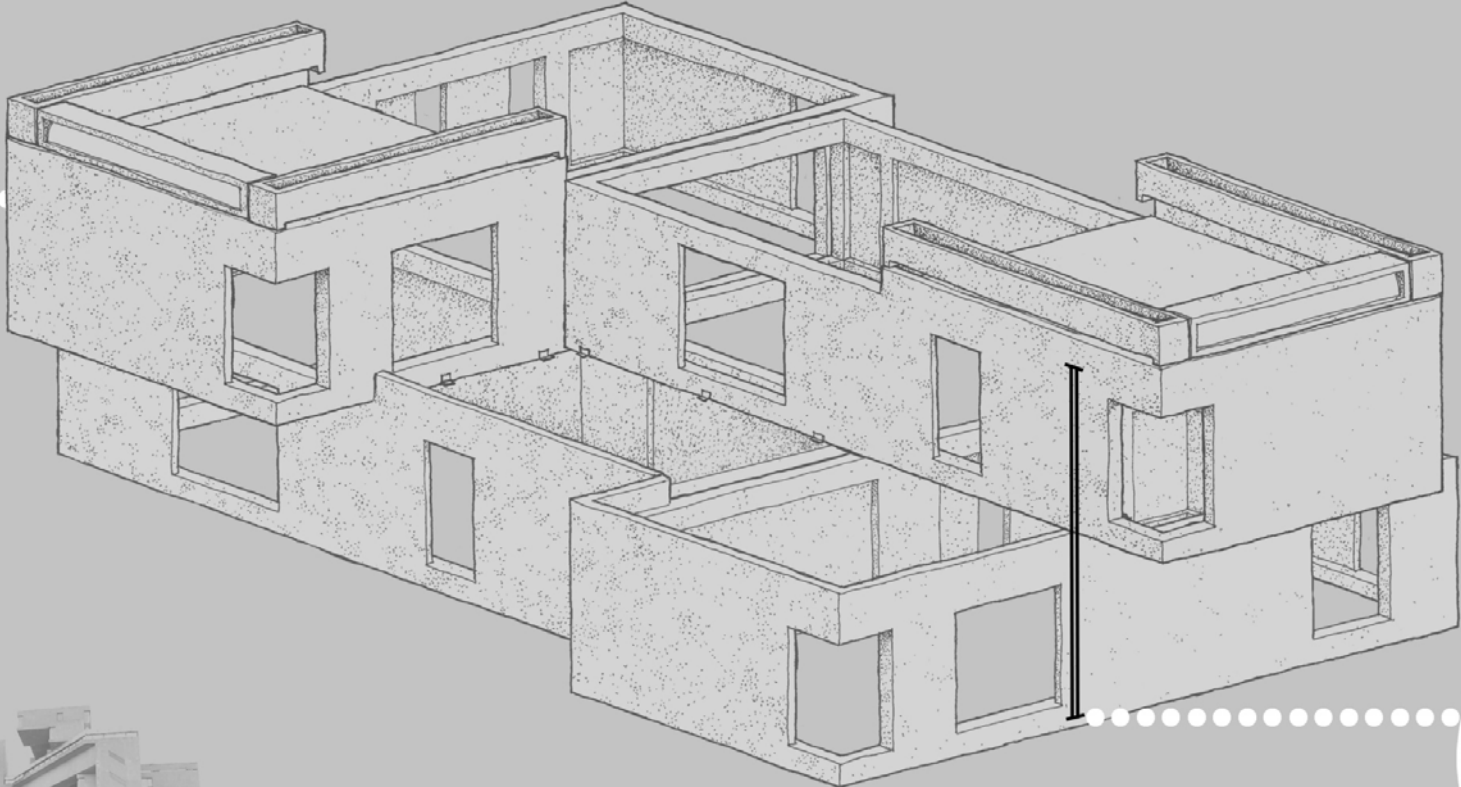



3

# MECANISMOS DE COMPOSICIÓN

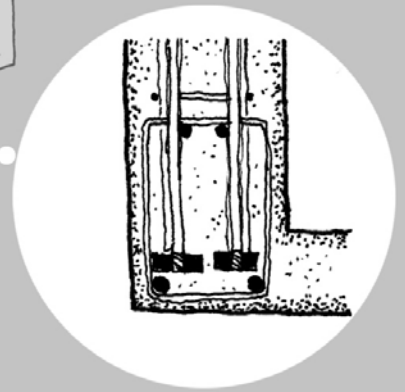
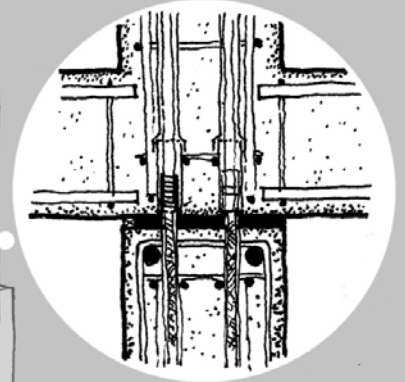
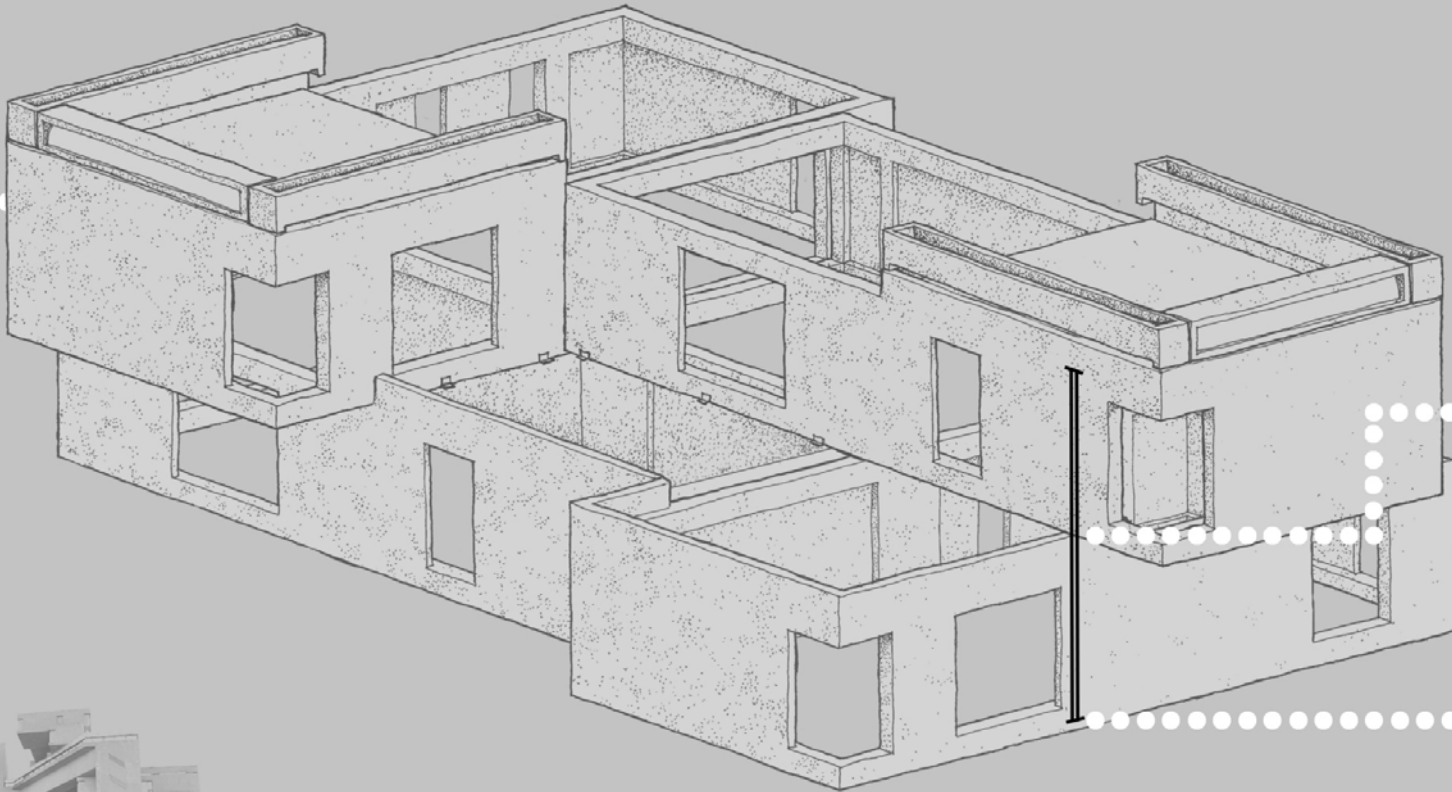

3

# MECANISMOS DE COMPOSICIÓN

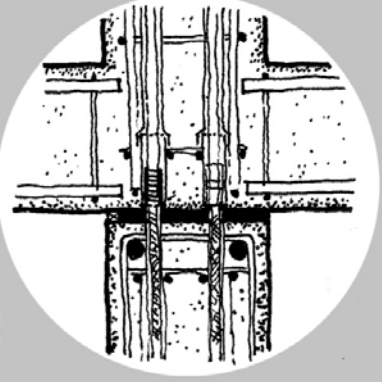
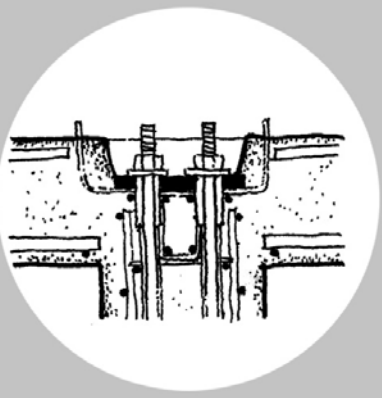
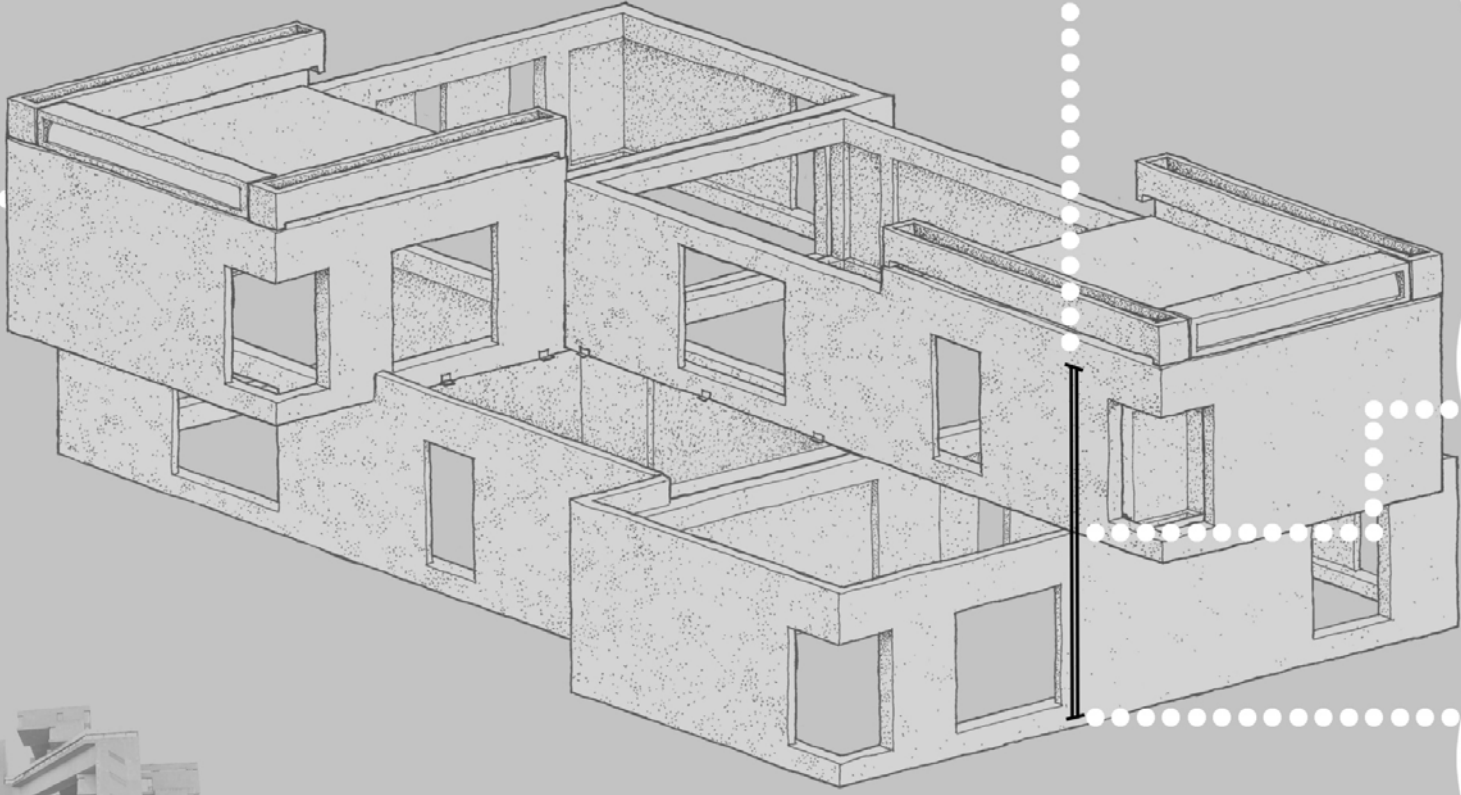

4

## CONSOLIDACIÓN DEL CONJUNTO

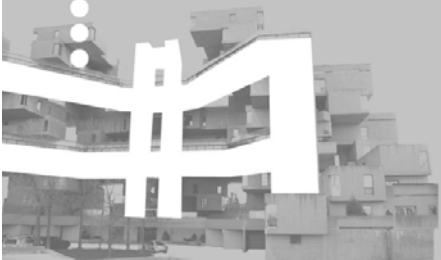

4

# CONSOLIDACIÓN DEL CONJUNTO

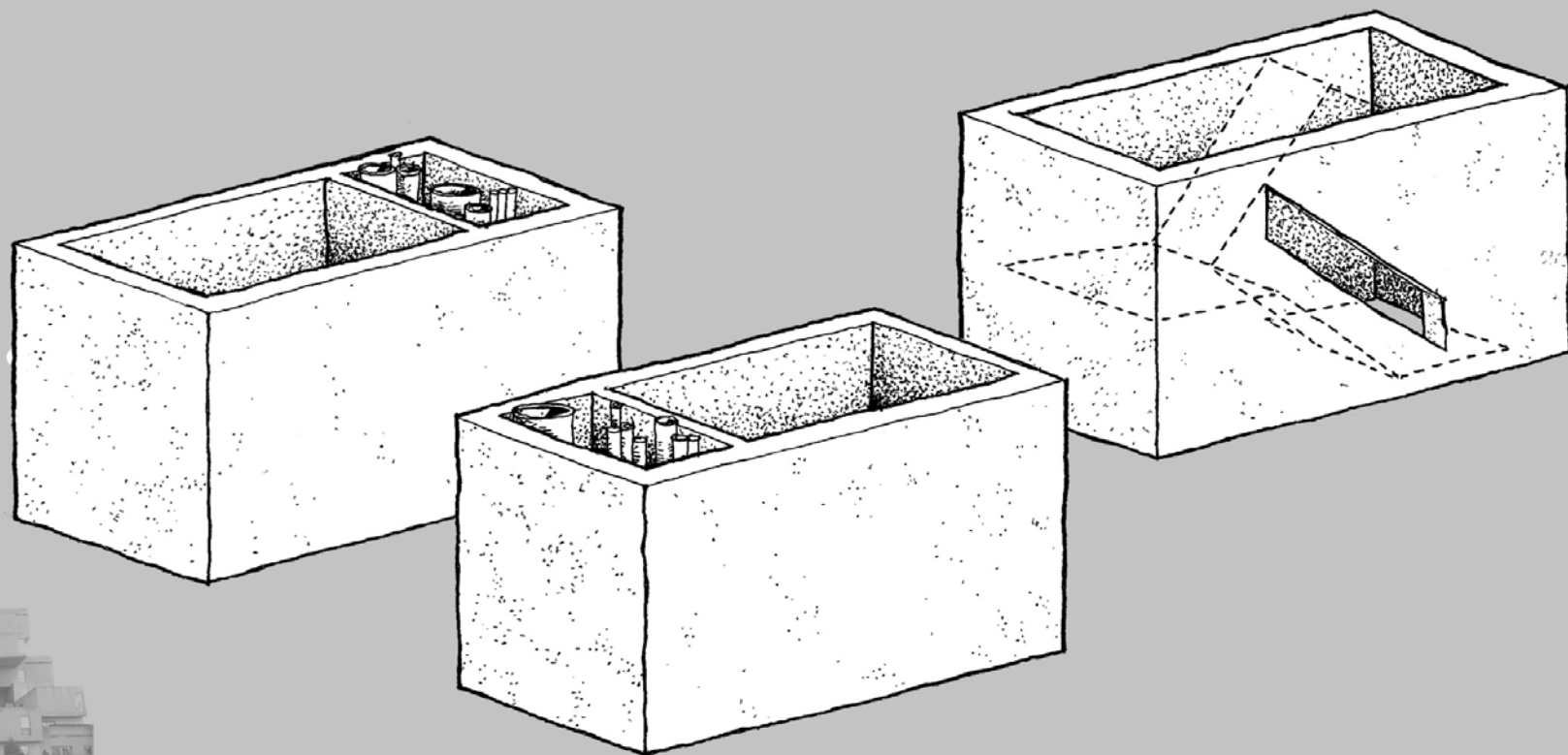

4

# CONSOLIDACIÓN DEL CONJUNTO

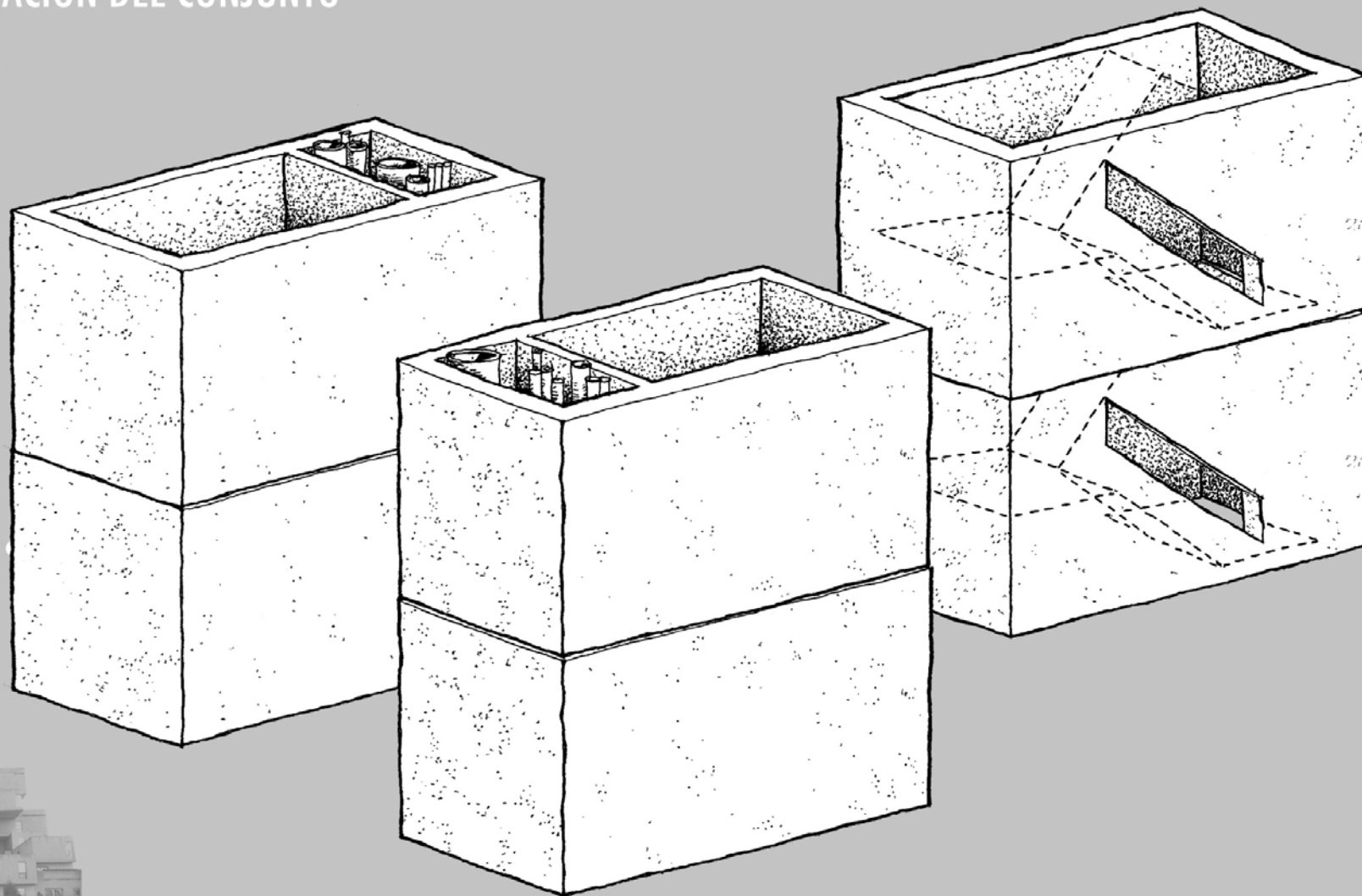

4

# CONSOLIDACIÓN DEL CONJUNTO

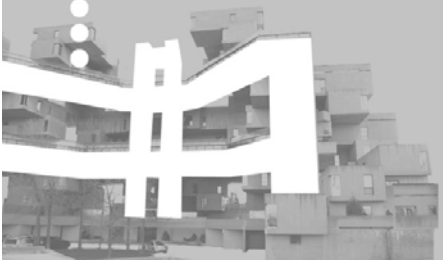
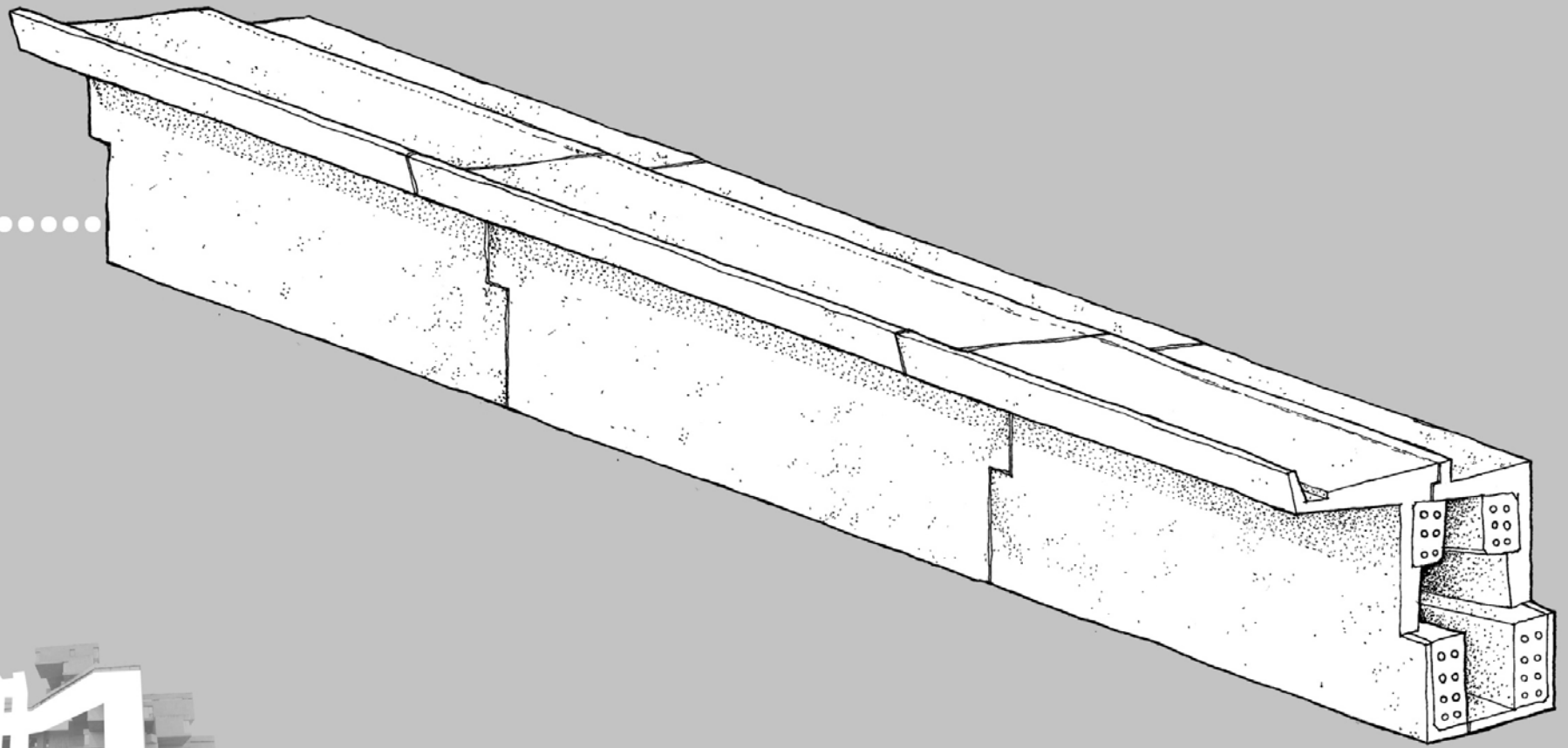

4

# CONSOLIDACIÓN DEL CONJUNTO

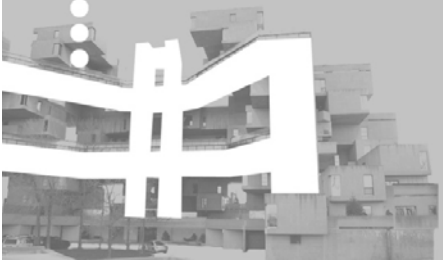
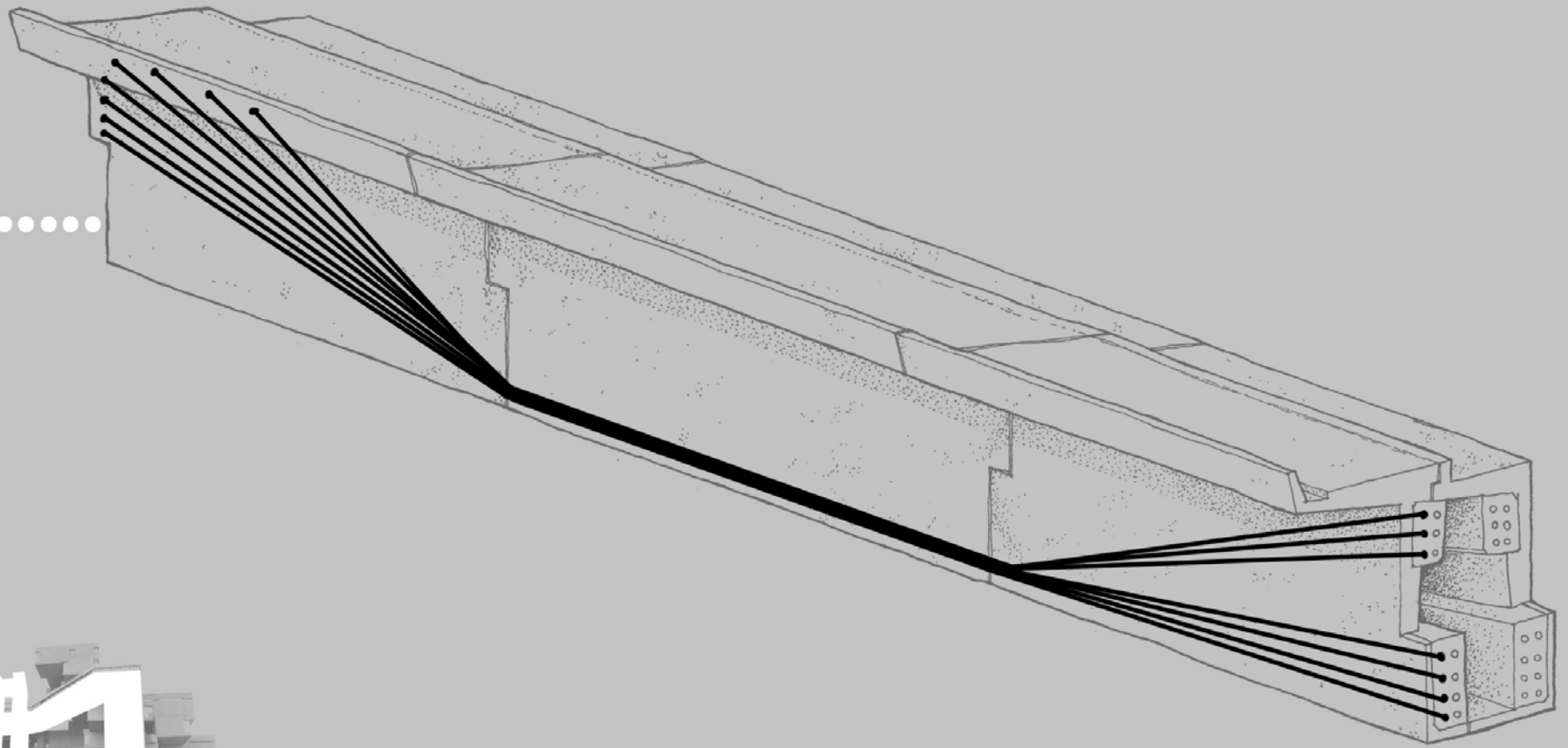

4

# CONSOLIDACIÓN DEL CONJUNTO

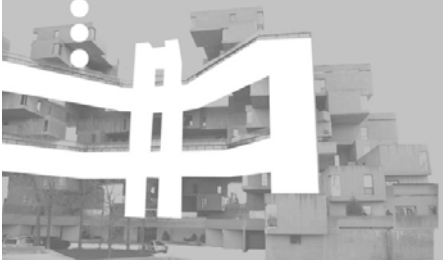
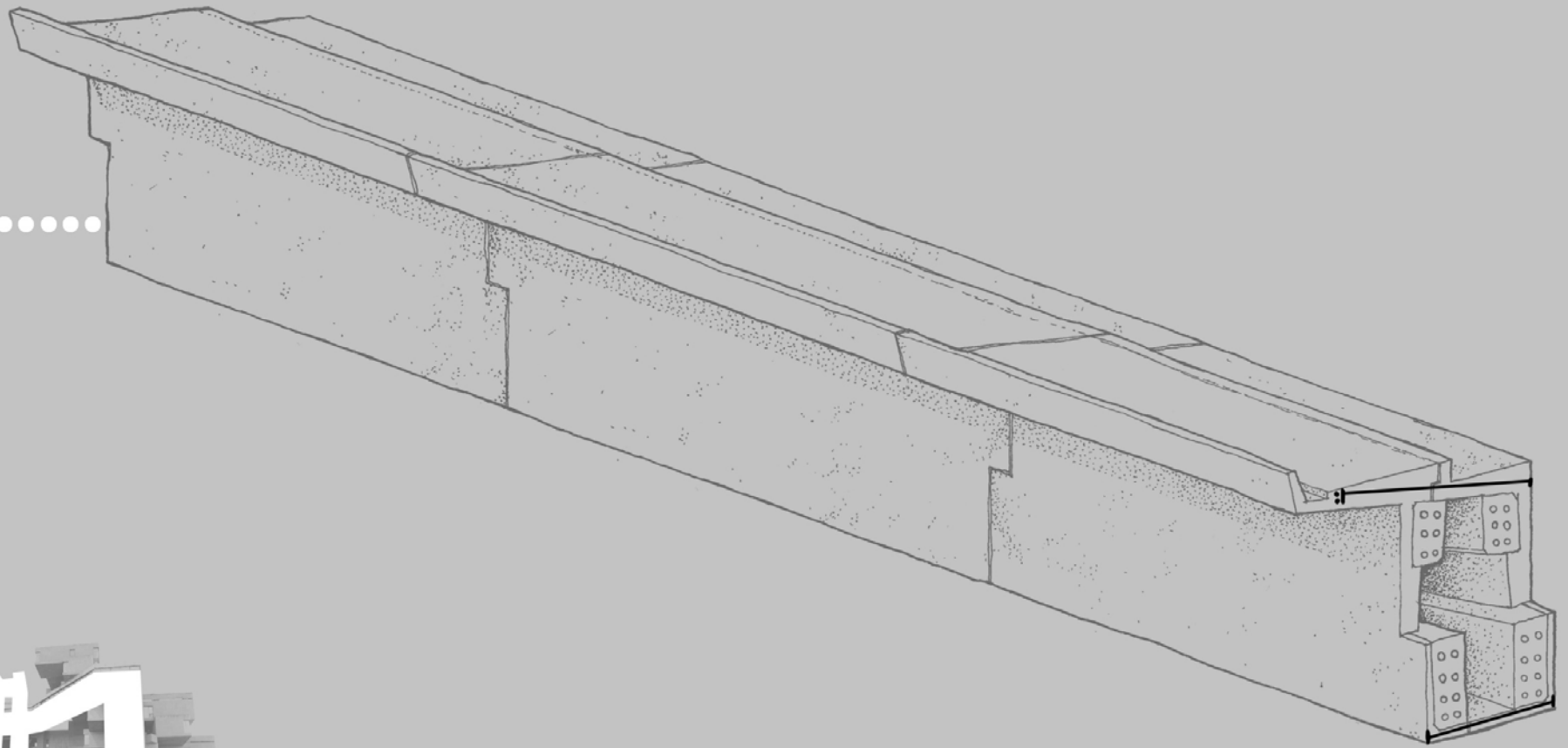



4

## CONSOLIDACIÓN DEL CONJUNTO



# BIBLIOGRAFÍA

## WEB

<http://aldea-irreductible.blogspot.com.es/2008/10/moshe-safdie-y-el-concepto-habitat-67.html>  
[http://www.habitat67.com/residences\\_en.html](http://www.habitat67.com/residences_en.html)  
<http://www.msafdie.com/#/projects/habitat67>  
<http://expo67.morenciel.com/an/index.php>  
<http://www.youtube.com/watch?v=93105aGE2vI>  
<http://travelwithfrankgehry.blogspot.com.es/2009/05/habitat67-by-moshe-safdie.html>  
<http://www.taringa.net/posts/info/1648235/Habitat-67-un-concepto-interesante.html>  
<http://es.paperblog.com/moshe-safdie-ii-habitat-67-890281/>  
[http://www.greatbuildings.com/buildings/Habitat\\_67.html](http://www.greatbuildings.com/buildings/Habitat_67.html)  
<http://www.youtube.com/watch?v=yCWZJBsHcQo&feature=endscreen&NR=1>  
<http://cac.mcgill.ca/safdie/habitat/constructionStage3.htm>  
<http://www.slideshare.net/maxz25/habitat-67-10340097>  
<http://www.urbanity.es/foro/edificios-en-general-inter/23766-canada-montreal-habitat-67-a.html>  
<http://www.cronologiadourbanismo.ufba.br/apresentacao.php?idVerbete=1226>  
<http://www.redac-coactfe.org/index.php/redac/redac-12/253-habitat-67>  
<http://proyectos4etsa.wordpress.com/2011/10/31/habitat-67-moshe-safdie-montreal-canada-1967/>  
<http://www.reporterosinfronteras.com/2009/12/habitat-67-extravagante-obra.html>

## LIBROS

*GLOBALCITIZEN THE ARCHITECTURE OF MOSHE SAFDIE* - Donald Albrecht  
0-35/3210B

*MOSHE SAFDIE I*  
0-35/2969B

